

Classification of Unilateral and Equitransitive Tilings by Squares of Three Sizes

Attila Bölcskei

*Department of Geometry, TU Budapest
H-1521 Budapest, Hungary
e-mail: bolcskei@math.bme.hu*

Abstract. After a break of 20 years and with the help of the fundamental book [2], the study of unilateral, equitransitive tilings of the plane by squares of three sizes was revived. First D. Schattschneider had found five possible tilings [2, p. 76] and Martini, Makai and Soltan generally characterized the unilateral tilings and obtained a new equitransitive arrangement [4]. They also described two other tilings constructed by B. Grünbaum. The problem to describe all possibilities remained open.

In this paper we shall derive all the unilateral and equitransitive tilings using the classification of the fundamental planigons. We prove, that only the eight known tilings are possible. We have learned that D. Schattschneider parallelly solved this problem, too. Our method is different from hers.

MSC 1991: 52C20

Keywords: tiling of the plane by squares, unilaterality, equitransitivity, planigon, plane group

1. Introduction

The problem how to tile the Euclidean plane by squares has been studied by many mathematicians (see, e.g., [2]). There are many kinds of questions, which restrict the attention to special conditions.

Our purpose here is to classify the so-called unilateral and equitransitive tilings of squares of three different sizes. The notion of *unilaterality* means that no two congruent tiles have a common side; on the other hand, we say that a tiling is *equitransitive* if for any two congruent tiles S and S' there is a congruence transform of the plane which maps S onto S' in such a manner, that the whole tiling is mapped onto itself.

Our problem had been investigated by D. Schattschneider [2, p. 76] 20 years ago. She found five different types of these tilings. Now we have to explain what “different” means.

Two tilings (T, Γ) and (T', Γ') , with corresponding symmetry groups Γ and Γ' , respectively, are *combinatorially equivariant* if there is a combinatorial tile-to-tile, edge-to-edge, vertex-to-vertex bijection ψ of T onto T' , preserving all incidences, such that $\psi\Gamma\psi^{-1} = \Gamma'$. In short, the mapping ψ carries the action of Γ on T onto the action of Γ' on T' as a conjugacy. Then the two tilings are said to be equivalent, and we look for the different equivalence classes (types).

Martini, Makai and Soltan described a new tiling in [4]. They omitted the equitransitivity and examined the local environments of every class of squares. According to their notation we shall name the squares by λ_1 , λ_2 and λ_3 , where we assume that the first one is the smallest and the last one is the greatest. As we shall cite the concept of a *vortex*, we shortly sketch its meaning: a tile is said to be a vortex if its sides are locally extendable in T to one orientation of the tile, but none of them is extendable according to the other orientation. As the authors reported, B. Grünbaum found two further tilings. The problem of describing every possible tiling they left open.

As my mentor E. Molnár was the lector of their paper [4], he immediately asked them if they wanted to solve this classification, otherwise he would give it to a doctoral student. In those days I began to work in this field. After my first steps E. Molnár and me had learned from Endre Makai that they would not deal with this question, but D. Schattschneider intended. Because of her doubtless priority I gave up the theme. In January D. Schattschneider kindly informed us about her results, which was in good accordance to mine. Because of the difference of the methods I intended to let this paper publish. (She worked with the local environments, the so called coronas of the squares. They are completely enumerated for every sizes of squares in [4]. She systematically examined all coronas which are in accordance with the local environment of the neighbours. This leads all the possible tilings if we consider greater areas.)

Our basic method is to find all the fundamental domains with face-identifications for any such tilings using the Poincaré angle criteria. Our great help is the classification of the 46 fundamental planigons by Delone and others [1] and by Z. Lučić and E. Molnár [3] in a different way. We say that a polygon \mathcal{P} is a *planigon* if one can tile the plane with their copies without gaps and overlappings, so that a plane group G acts transitively on their tiles. In the following we shall show how the machinery works.

The tilings will be denoted by their appearance in [2, p. 76] (from Sch. 1 to 5) and in [4] (MMS and G. 1, G. 2).

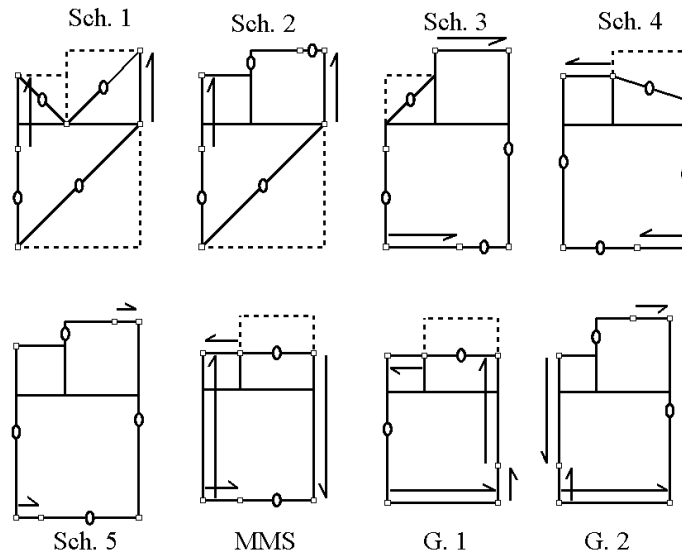

Figure 1

2. Reduction of the feasible plane groups

At first we make some general remarks.

- Obviously, it is sufficient to examine the L-shaped block in our Figure 2 as containing a fundamental domain of a plane group. This is a simple consequence of the facts that $\lambda_3 = \lambda_1 + \lambda_2$ holds and the λ_3 -squares are not vortices (see [4], Th. 3, equitransitivity, and Cor. 1.). So there exists a side where the neighbours have to be λ_1 - and λ_2 -squares.
- As we intend to extend the L-shaped block to the whole tiling by equitransitivity, we take first into account the possible transformations, which serve unilateral tilings.
- We show some restrictions:
 - for a λ_1 -square the reflection is not allowed, because of the overlapping,
 - for a λ_2 -square the reflection is not allowed, because it would not be a vortex,
 - for a λ_3 -square the reflection is not allowed. Namely, there are two kinds of reflection lines. The first one is a diagonal of the λ_3 -square. In this case this square would have two neighbours of the same type at the corner, in contradiction to the fact that the neighbours have to be a vortex. The second position of the mirror line halves the square parallelly with the base (Fig. 3). If we consider the side MR , then there are two possibilities: either two squares of the same type meet at the reflection line (right) or there is only one neighbour in symmetric position at the side (see left). The first case contradicts the unilaterality. If the second case holds than if the square is not of λ_3 -type, than it would not be a vortex. If it is of λ_3 -type, than the tiling would not be unilateral.

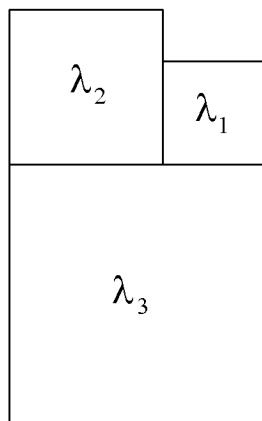

Figure 2

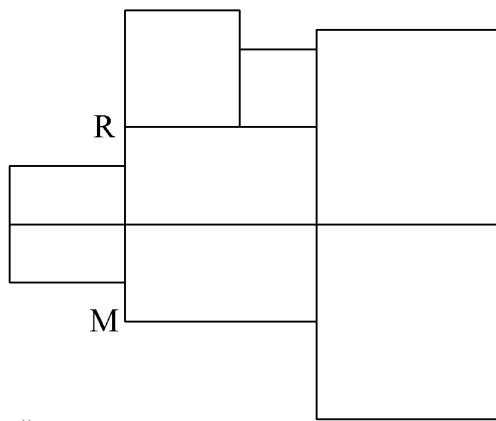

Figure 3

- We claim that the fourfold rotation is out of question, too. Namely, neither a centre of a λ_1 nor of a λ_2 tile can be equipped with this kind of transformation, because this would cause overlappings at the L-shaped block. The center of a λ_3 -square is not a fourfold rotation center, since this would contradict the fact that the smaller squares are vortices. Obviously, the rotation center cannot lie on the boundary. Rotation centers at corners would cause non-unilateral tilings.
- If we enumerate those plane groups for which the corresponding planigons contain only permitted transformations, we get only four ones, namely **p1**, **p2**, **pg** and **pgg**.

3. The eight classes of fundamental domains

As the former examinations show, the automorphisms of a square in any type are only the twofold rotations and the identity. That means the possible fundamental domains can be of eight types, containing a half or a whole square from each square-class. We enumerate them starting with the smallest size and finishing with the largest one. We observe that the group **pg** allows only the L-shaped block (1-1-1) as a fundamental domain.

It is important that in every remaining case the fundamental domain has at least five vertices because of its shape. (It is sufficient to deal only with simply-connected domains. Now, a side is a common part of two fundamental domains, a vertex is that of at least three domains.)

This fact causes a great reduction of the number of planigons: for **p1** we have only one domain: $P_{6,7}$; for **p2** remain only two types: $P_{6,4}$ and $P_{5A,1}$; for **pgg** four types: $P_{6,5}$, $P_{6,2}$, $P_{5A,2}$ and $P_{5B,2}$; and for **pg** again only two types: $P_{6,6}$, $P_{6,3}$, where the notation comes from [1]. In Fig. 4 we have collected them, with the corresponding face-identifications.

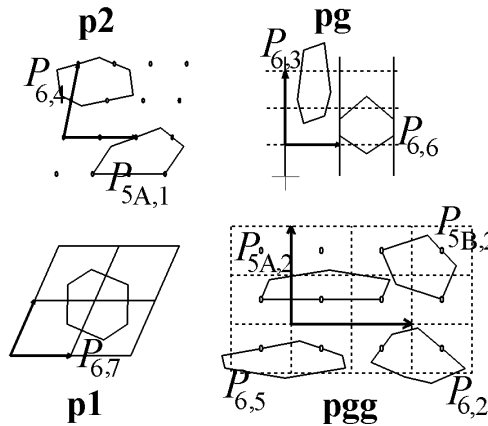

Figure 4

- type 2-2-2
The three rotation centers involve the group **p2**, and this implies the fourth center lying on a square boundary. This tiling is the well-known Sch. 1.
- type 2-2-1 (Fig. 5)

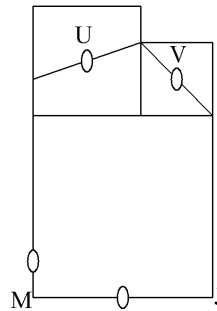

Figure 5

First we assert that the group **pgg** is out of question. This is true because then we need glide reflection which would be parallel with UV and would form an angle $\pm \frac{\pi}{4}$ with the segment MJ , a contradiction. Similar reasoning will be true for the following two cases.

It is easy to see that the only possibility would be that shown in Fig. 5, but then the unilaterality would not hold at a λ_3 -square.

- type 2-1-2 (Fig. 6)

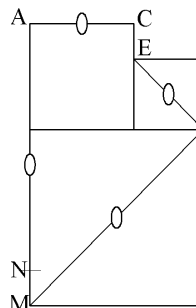

Figure 6

The only arrangement is shown in Figure 6. We have to pair CE and NM and we are up against unilaterality at a λ_2 -square.

- type 1-2-2

This case is almost the same as in the former case.

From now on we face to those fundamental domains which may contain the broken line CEF mentioned simply as a “creek”. In Figure 7 we have indicated all the permitted pairings of the creek and the boundary of the entire L-block as well. For $\lambda_2 \neq 2\lambda_1$ only the first pairings $\varphi_1 \dots \varphi_{13}$ are possible, but the last ones $\varphi_{14} \dots \varphi_{18}$ imply equality. Every other transformation either leads to overlappings or contradicts to the unilaterality.

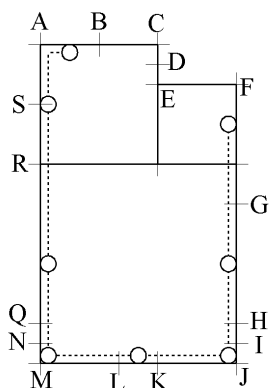

Figure 7a

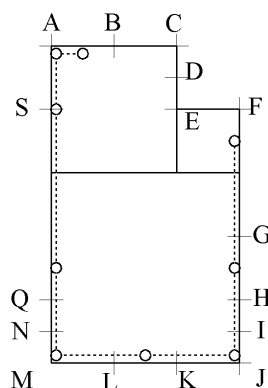

Figure 7b

- φ_1 : $B(C)D \rightarrow F(E)D$, halfturn
- φ_2 : $C(D)(E)F \rightarrow Q(N)(M)L$, translation
- φ_3 : $C(D)(E)F \rightarrow H(I)(J)K$, glide reflection
- φ_4 : $C(E)F \rightarrow L(M)Q$, glide reflection
- φ_5 : glide reflection along AM
- φ_6 : glide reflection along FJ
- φ_7 : glide reflection along AC
- φ_8 : glide reflection along MJ
- φ_9 : (a part of) $AM \rightarrow$ (a part of) JF , glide reflection
- φ_{10} : (a part of) $MJ \rightarrow$ (a part of) JF , glide reflection
- φ_{11} : (a part of) $MJ \rightarrow$ (a part of) AM , glide reflection
- φ_{12} : with dashed line we show the positions of possible halfturns, where at empty circles the line is discontinuous
- φ_{13} : every possible translation

only for $\lambda_2 = 2\lambda_1$

- φ_{14} : $C(D)(E)F \rightarrow S(A)B$, glide reflection
- φ_{15} : $AC \rightarrow JL$, glide reflection

- φ_{16} : (a part of) $AC \rightarrow$ (a part of) MA , glide reflection
- φ_{17} : $AC \rightarrow GJ$, glide reflection
- φ_{18} : $AB \rightarrow HJ$, glide reflection

The L-shaped block, as fundamental domain, has six vertices (as many as the other truncated ones). Considering the list above we see that none of the face-pairings would increase this number except for the halfturn (φ_1). In this case we have to permit fundamental pentagons and hexagons, in the other cases only the hexagons have to be examined. (**pg** is out of question, because halfturns do not occur there.)

We have a remark to φ_2 , too. In this case the groups **pgg** and **pg** are excluded, because the translation is not parallel with any square diagonal, the possible direction of glide reflections. So it is sufficient to check the realizability of the planigon $P_{6,4}$ of **p2** (and for 1-1-1 the $P_{6,7}$ of **p1**).

For φ_3 we mention that $P_{6,5}$ and $P_{5A,1}$ cannot be equipped with this transformation because the translation would be too long. This is also true for the planigons $P_{6,6}$ and $P_{6,3}$ of **pg**. It remains only the case of $P_{6,2}$.

For φ_4 we have two possibilities of **pgg** and two possibilities of **pg** (for 1-1-1), which is a consequence of the facts above.

The “creek-transformation” φ_{14} is analogous to φ_3 . Now the only remaining possibility is $P_{6,2}$.

So the planigons to be examined are the following.

| | |
|---------------------------|--|
| φ_1 | $P_{6,4}, P_{5A,1}$ and $P_{6,5}, P_{6,2}, P_{5A,2}, P_{5B,2}$ |
| φ_2 | $P_{6,4}$ (and for 1-1-1 $P_{6,7}$, too) |
| φ_3, φ_{14} | $P_{6,2}$ |
| φ_4 | $P_{6,5}, P_{6,2}$ (and for 1-1-1 $P_{6,6}$ and $P_{6,3}$, too) |

• 1-1-1 (Fig. 7)

We introduce subitems according to the transformations of the creek.

– φ_1

Let us consider Fig. 7. Now we are going to search the image of AB .

* φ_7

Now there remains only $P_{6,2}$, but we have no good construction with it.

* φ_{13} onto JM

In this case we have a halfturn which is adjacent with a translation, but just with one of the paired sides. There are only two hexagons that satisfy this condition, namely, $P_{6,4}$ and $P_{6,5}$. In this cases the other adjacent transformation of the rotation must be a halfturn, too. In this way FJ is mapped onto itself and AB is in pair with KJ . We are able to finish the face-identification only by two halfturns, determining the tiling Sch. 5.

For $\lambda_2 = 2\lambda_1$ there are three other possible transformations for AB .

* φ_{16}

The reasoning is similar as in the former case, but now the segment FJ would have no pair.

* φ_{17}

There would remain four segments with different lengths, and the side-pairings would not be sufficient to map them onto each other.

* φ_{18}

This case leads to the eighth tiling. We have only one way to close the pairing procedure: φ_{10} for MJ and, finally, φ_{12} for MA . From this we get G. 2.

– φ_2

$P_{6,4}$ does not lead to a solution. Now we have to deal also with $P_{6,7}$ that leads to the same arrangement as Sch. 1. The tiling has also **p2** symmetries as an extension of **p1**, but if we tiled with marked squares, the pattern would be different from Sch. 1.

– φ_3

$P_{6,2}$ does not lead to a tiling.

– φ_4

The only way to pair AC is φ_{17} . The remaining two halfturns are not enough to make the face-identifications complete. The **pg** cases are out of question because we cannot find any other glide reflection parallel to φ_4 which would have the same translation part as φ_4 .

– φ_{14}

Our only candidate $P_{6,2}$ will not serve a “good” tiling.

• 2-1-1 (Fig. 8)

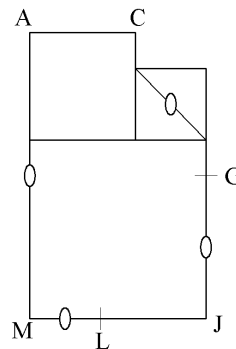

Figure 8

– φ_1

Now we consider the component AC . If we look for the image of it there are few possibilities.

* φ_7

Again, there only remains $P_{6,2}$, not yielding a good construction.

* φ_{13} into JM

In this case we have a halfturn which is adjacent with a translation, but just with one of the paired sides. Again, this condition excludes $P_{6,5}$, therefore the other adjacent transformation of the rotation must be a halfturn, too. In this way GJ is mapped onto itself and AC is in pair with LJ . We are able to finish the face-identification only by two halfturns, determining the tiling Sch. 3.

For $\lambda_2 = 2\lambda_1$ there are three other possible transformations for AC .

* φ_{16}

The reasoning is similar as in the former case, but now the segment GJ would have no pair.

* φ_{17}

There is no such planigon, where a halfturn is adjacent at both sides with the same glide reflection.

* φ_{18}

The remaining $P_{6,2}$ will not lead to a solution.

– φ_2

As $P_{6,4}$ is not convenient there is not such a construction.

– φ_3

$P_{6,2}$ will not lead to a solution.

– φ_4

Again, the situation of the symmetry operations allows only $P_{6,2}$, but the remaining boundary segments cannot map onto each other by a glide reflection and a halfturn.

– φ_{14}

$P_{6,2}$ does not yield a tiling.

• 1-2-1

– φ_1 (Fig. 9)

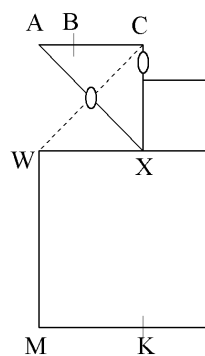

Figure 9

The only arrangement which permits the halfturn can be seen in the picture. The segment XW is mapped into AC . But then we gain four different sides, and the permitted three transformations are not convenient.

– φ_2

The planigon $P_{6,4}$ serves as fundamental domain and provides us the well-known tiling Sch. 4.

– φ_3 (Fig. 10)

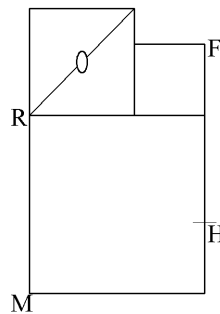

Figure 10

The second (horizontal) glide reflection is permitted if and only if the segments FH and MR have the same length. The first one is $\lambda_3 + \lambda_1 - (\lambda_2 - \lambda_1) = 2\lambda_1 + \lambda_3 - \lambda_2$, the second one is λ_3 . That means that only the case $\lambda_2 = 2\lambda_1$ leads to an equitransitive and unilateral tiling of the plane denoted by MMS.

– φ_4 (Fig. 11)

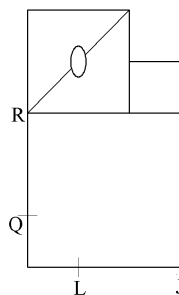

Figure 11

Our only candidate is $P_{6,2}$, because the glide reflection and the rotation are adjacent here. On the boundary there remain three segments from which we have to pair QR and JL by a glide reflection. Their lengths are $\lambda_3 - \lambda_1$ and $\lambda_3 + \lambda_1 - \lambda_2$, respectively. It means that we can gain a tiling only for $\lambda_2 = 2\lambda_1$. This is G. 1.

• 1-1-2 (Fig. 12)

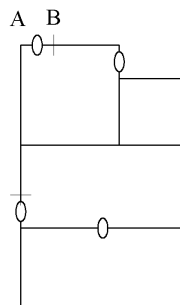

Figure 12

– φ_1

We see that for the segment AB there is not any pairing except a halfturn (φ_{12}). In this way the group must be $\mathbf{p2}$ which induces the fourth rotation center lying on the boundary. Finally the translation ends the face-identification process, with the fundamental domain $P_{6,4}$ that leads to the tiling Sch. 2.

If $\lambda_2 = 2\lambda_1$, then there are further possibilities.

φ_{14} and φ_{15} are out of question because the boundary does not contain both sides to be paired. For $\varphi_{16} \dots \varphi_{18}$ we have to deal only with $P_{6,5}$ and $P_{6,2}$. Neither the first one is possible (the two halfturns are not adjacent), nor the second one (the two glide reflection axes would form an angle of $\frac{\pi}{4}$).

– φ_2

This transformation is not allowed, because the boundary does not contain both the segments to be paired. This is true also for φ_3 and φ_4 , respectively.

– φ_{14}

It is easy to see that there is no proper glide reflection perpendicular to φ_{14} , and so $P_{6,2}$ is not realizable.

Now we formulate our result.

Theorem 1. *There exist exactly eight types of unilateral and equitransitive tilings of the plane by squares of three different sizes.*

We intend to continue the investigations of the tilings omitting the unilaterality condition. The feasible constructions obviously will contain the former ones. However, we shall have some new interesting types, with other plane groups as well.

References

- [1] Delone, B. N.; Dolbilin, N. P.; Štogrin, M. I.: *Combinatorial and Metric Theory of Planigons*. Proc. Steklov Inst. Math. (4) **148** (1980), 111–141.
- [2] Grünbaum, B.; Shepard, G. C.: *Tilings and Patterns*. W. H. Freeman 1987, 72–81.
- [3] Lučić, Z.; Molnár, E.: *Combinatorial Classification of Fundamental Domains of Finite Area for Planar Discontinuous Isometry Group*. Arch. Math. **54** (1990), 511–520.
- [4] Martini, H.; Makai, E.; Soltan, V.: *Unilateral Tilings of the Plane with Squares of Three Sizes*. Beitr. Algebra Geom. **39** (1998), 481–495.

Received March 2, 1999