

Global configurations of singularities for quadratic differential systems with exactly three finite singularities of total multiplicity four

Joan C. Artés¹, Jaume Llibre^{✉1}, Dana Schlomiuk² and
Nicolae Vulpe³

¹Department of Mathematics, Universitat Autònoma de Barcelona, 08193 Barcelona, Spain

²Département de Mathématiques et de Statistiques, Université de Montréal, Canada

³Academy of Science of Moldova, 5 Academiei str, Chişinău, MD-2028, Moldova

Received 2 February 2015, appeared 12 August 2015

Communicated by Alberto Cabada

Abstract. In this article we obtain the *geometric classification* of singularities, finite and infinite, for the two subclasses of quadratic differential systems with total finite multiplicity $m_f = 4$ possessing exactly three finite singularities, namely: systems with one double real and two complex simple singularities (31 configurations) and (ii) systems with one double real and two simple real singularities (265 configurations). We also give here the global bifurcation diagrams of configurations of singularities, both finite and infinite, with respect to the *geometric equivalence relation*, for these classes of quadratic systems. The bifurcation diagram is done in the 12-dimensional space of parameters and it is expressed in terms of polynomial invariants. This gives an algorithm for determining the geometric configuration of singularities for any system in anyone of the two subclasses considered.

Keywords: quadratic vector fields, infinite and finite singularities, affine invariant polynomials, Poincaré compactification, configuration of singularities, geometric equivalence relation.

2010 Mathematics Subject Classification: 58K45, 34C05, 34A34.

1 Introduction and statement of main results

We consider here differential systems of the form

$$\frac{dx}{dt} = p(x, y), \quad \frac{dy}{dt} = q(x, y), \quad (1.1)$$

where $p, q \in \mathbb{R}[x, y]$, i.e. p, q are polynomials in x, y over \mathbb{R} . We call *degree* of a system (1.1) the integer $m = \max\{\deg p, \deg q\}$. In particular we call *quadratic* a differential system (1.1) with $m = 2$. We denote here by **QS** the whole class of real quadratic differential systems.

[✉]Corresponding author. Email: jllibre@mat.uab.cat

The study of the class **QS** has proved to be quite a challenge since hard problems formulated more than a century ago, are still open for this class. It is expected that we have a finite number of phase portraits in **QS**. We have phase portraits for several subclasses of **QS** but to obtain the complete topological classification of these systems, which occur rather often in applications, is a daunting task. This is partly due to the elusive nature of limit cycles and partly to the rather large number of parameters involved. This family of systems depends on twelve parameters but due to the group action of real affine transformations and time homotheties, the class ultimately depends on five parameters which is still a rather large number of parameters. For the moment only subclasses depending on at most three parameters were studied globally, including global bifurcation diagrams (for example [1]). On the other hand we can restrict the study of the whole quadratic class by focusing on specific global features of the systems in this family. We may thus focus on the global study of singularities and their bifurcation diagram. The singularities are of two kinds: finite and infinite. The infinite singularities are obtained by compactifying the differential systems on the sphere, on the Poincaré disk, or on the projective plane as defined in Section 2 (see [15,18]).

The global study of quadratic vector fields began with the study of these systems in the neighborhood of infinity [14,19,24,25,27]. In [8] the authors classified topologically (adding also the distinction between nodes and foci) the whole quadratic class, according to configurations of their finite singularities.

To reduce the number of phase portraits in half in topological classification problems of quadratic systems, the *topological equivalence relation* was taken to mean the existence of a homeomorphism of the phase plane carrying orbits to orbits and *preserving or reversing* the orientation.

We use the concepts and notations introduced in [2] and [3] which we describe in Section 2. To distinguish among the foci (or saddles) we use the notion of order of the focus (or of the saddle) defined using the algebraic concept of Poincaré–Lyapunov constants. We call strong focus (or strong saddle) a focus (or a saddle) whose linearization matrix has non-zero trace. Such a focus (or saddle) will be denoted by f (respectively s). A focus (or saddle) with zero trace is called a weak focus (weak saddle). We denote by $f^{(i)}$ ($s^{(i)}$) the weak foci (weak saddles) of order i and by c and $\$$ the centers and integrable saddles. For more notations see Subsection 2.5.

In the topological classification no distinction was made among the various types of foci or saddles, strong or weak of various orders. However, these distinctions of an algebraic nature are very important in the study of perturbations of systems possessing such singularities. Indeed, the maximum number of limit cycles which can be produced close to the weak foci of a system in **QS** in perturbations inside the class of all **QS** depends on the orders of the foci.

There are also three kinds of simple nodes: nodes with two characteristic directions (the generic nodes), nodes with one characteristic direction and nodes with an infinite number of characteristic directions (the star nodes). The three kinds of nodes are distinguished algebraically. Indeed, the linearization matrices of the two direction nodes have distinct eigenvalues, they have identical eigenvalues and they are not diagonal for the one direction nodes, and they have identical eigenvalues and they are diagonal for the star nodes (see [2,3,5]). We recall that the star nodes and the one direction nodes could produce foci in perturbations.

Furthermore a generic node at infinity may or may not have the two exceptional curves lying on the line at infinity. This leads to two different situations for the phase portraits. For this reason we split the generic nodes at infinity in two types as indicated in Subsection 2.5.

The *geometric equivalence relation* (see further below) for finite or infinite singularities, intro-

duced in [2] and used in [3–6], takes into account such distinctions. This equivalence relation is also deeper than the *qualitative equivalence relation* introduced by Jiang and Llibre in [17] because it distinguishes among the foci (or saddles) of different orders and among the various types of nodes. This equivalence relation induces also a deeper distinction among the more complicated degenerate singularities.

In quadratic systems weak singularities could be of orders 1, 2 or 3 [12]. For details on Poincaré–Lyapunov constants and weak foci of various orders we refer to [18, 23]. As indicated before, algebraic information plays a fundamental role in the study of perturbations of systems possessing such singularities. In [28] necessary and sufficient conditions for a quadratic system to have weak foci (saddles) of orders $i, i=1,2,3$ are given in invariant form.

For the purpose of classifying **QS** according to their singularities, finite or infinite, we use the *geometric equivalence relation* which involves only algebraic methods. It is conjectured that there are around 1800 distinct *geometric configurations* of singularities. The first step in this direction was done in [2] where the global classification of singularities at infinity of *the whole class QS*, was done according to the *geometric equivalence relation* of configurations of infinite singularities. This work was then partially extended to also incorporate finite singularities. We initiated this work in [3] where this classification was done for the case of singularities with a total finite multiplicity $m_f \leq 1$, the work was continued in [4] where the classification was done for $m_f = 2$ and in [5] and [6] where the classification was done for $m_f = 3$. The case $m_f = 4$ has also been split in several papers the first being [7] which contains exactly three subclasses possessing two distinct finite singularities.

In the present article our goal is to go one step further in the *geometric classification* of global configurations of singularities by studying here the case of finite singularities with total finite multiplicity four and exactly three finite singularities.

We recall below the notion of *geometric configuration of singularities* defined in [4] for both finite and infinite singularities. We distinguish two cases:

1) Consider a system with a finite number of singularities, finite and infinite. In this case we call *geometric configuration of singularities*, finite and infinite, the set of all these singularities (real and complex) together with additional structure consisting of i) their multiplicities, ii) their local phase portraits around real singularities, each endowed with additional geometric structure involving the concepts of tangent, order and blow-up equivalence defined in Section 4 of [2] (or [3]) and Section 3 of [4].

2) if the line at infinity is filled up with singularities, in each one of the charts at infinity, the corresponding system in the Poincaré compactification (see Section 2) is degenerate and we need to do a rescaling of an appropriate degree of the system, so that the degeneracy be removed. The resulting systems have only a finite number of singularities on the line at infinity. In this case we call *geometric configuration of singularities*, finite and infinite, the set of all points at infinity (they are all singularities) in which we single out the singularities at infinity of the “reduced” system, taken together with their local phase portraits and we also take the local phase portraits of finite singularities each endowed with additional geometric structure to be described in Section 2.

Remark 1.1. We note that the geometric equivalence relation for configurations is much deeper than the topological equivalence. Indeed, for example the topological equivalence does not distinguish between the following three configurations which are geometrically non-equivalent: **1)** $n, f; \binom{1}{1}SN, \odot, \odot$, **2)** $n, f^{(1)}; \binom{1}{1}SN, \odot, \odot$, and **3)** $n^d, f^{(1)}; \binom{1}{1}SN, \odot, \odot$ where n and n^d mean singularities which are nodes, respectively two directions and one direction

nodes, capital letters indicate points at infinity, \odot in case of a complex point and SN a saddle-node at infinity and $(\overline{1})$ encodes the multiplicities of the saddle-node SN . For more details see the notation in Subsection 2.5.

The invariants and comitants of differential equations used for proving our main result are obtained following the theory of algebraic invariants of polynomial differential systems, developed by Sibirsky and his disciples (see for instance [11, 13, 21, 26, 29]).

Our results are stated in the following theorem.

Main theorem. (A) *We consider here all configurations of singularities, finite and infinite, of quadratic vector fields with finite singularities of total multiplicity $m_f = 4$ possessing exactly three distinct finite singularities. These configurations are classified in Diagrams 1.1, 1.2 according to the geometric equivalence relation. We have 296 geometrically distinct configurations of singularities, finite and infinite. More precisely 31 geometrically distinct configurations with one double and two complex simple finite singularities and 265 with one double and two simple real finite singularities.*

(B) *Necessary and sufficient conditions for each one of the 296 different geometric equivalence classes can be assembled from these diagrams in terms of 26 invariant polynomials with respect to the action of the affine group and time rescaling appearing in the Diagrams 1.1, 1.2 (see Remark 1.2 for a source of these invariants).*

(C) *The Diagrams 1.1, 1.2 actually contain the global bifurcation diagrams in the 12-dimensional space of parameters, of the global geometric configurations of singularities, finite and infinite, of these subclasses of quadratic differential systems and provide an algorithm for finding for any given system in any of the two families considered, its respective geometric configuration of singularities.*

Remark 1.2. The diagrams are constructed using the invariant polynomials μ_0, μ_1, \dots which are defined in Section 5 of [6] and may be downloaded from the web page:

<http://mat.uab.es/~artes/articles/qvfinvariants/qvfinvariants.html>

together with other useful tools.

In Diagrams 1.1, 1.2 the conditions on these invariant polynomials are listed on the left side of the diagrams, while the specific geometric configurations appear on the right side of the diagram. These configurations are expressed using the notation described in Subsection 2.5.

2 Concepts and results in the literature useful for this paper

2.1 Compactification on the sphere and on the Poincaré disk

Planar polynomial differential systems (1.1) can be compactified on the 2-dimensional sphere as follows. We first include the affine plane (x, y) in \mathbb{R}^3 , with its origin at $(0, 0, 1)$, and we consider it as the plane $z = 1$. We then use a central projection to send the vector field to the upper and to the lower hemisphere. The vector fields thus obtained on the two hemispheres are analytic and diffeomorphic to our vector field on the (x, y) plane. By a theorem stated by Poincaré and proved in [16] there exists an analytic vector field on the whole sphere which simultaneously extends the vector fields on the two hemispheres, modulo a change of the independent variables, to the whole sphere. We call *Poincaré compactification on the sphere* of the planar polynomial system, the restriction of the vector field thus obtained on the sphere, to the upper hemisphere completed with the equator. For more details we refer to [15].

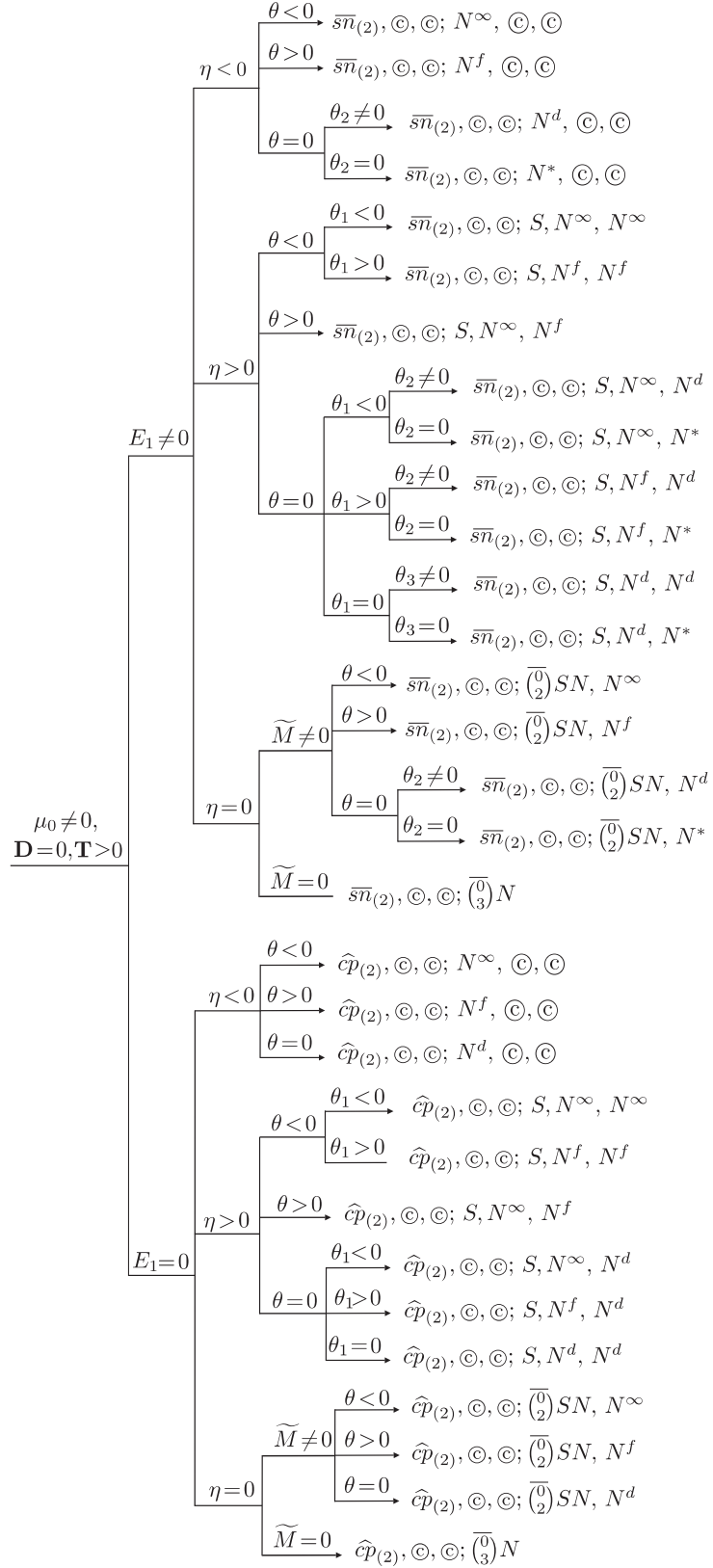
Diagram 1.1: Global configurations: the case $\mu_0 \neq 0, \mathbf{D} = 0, \mathbf{T} > 0$.

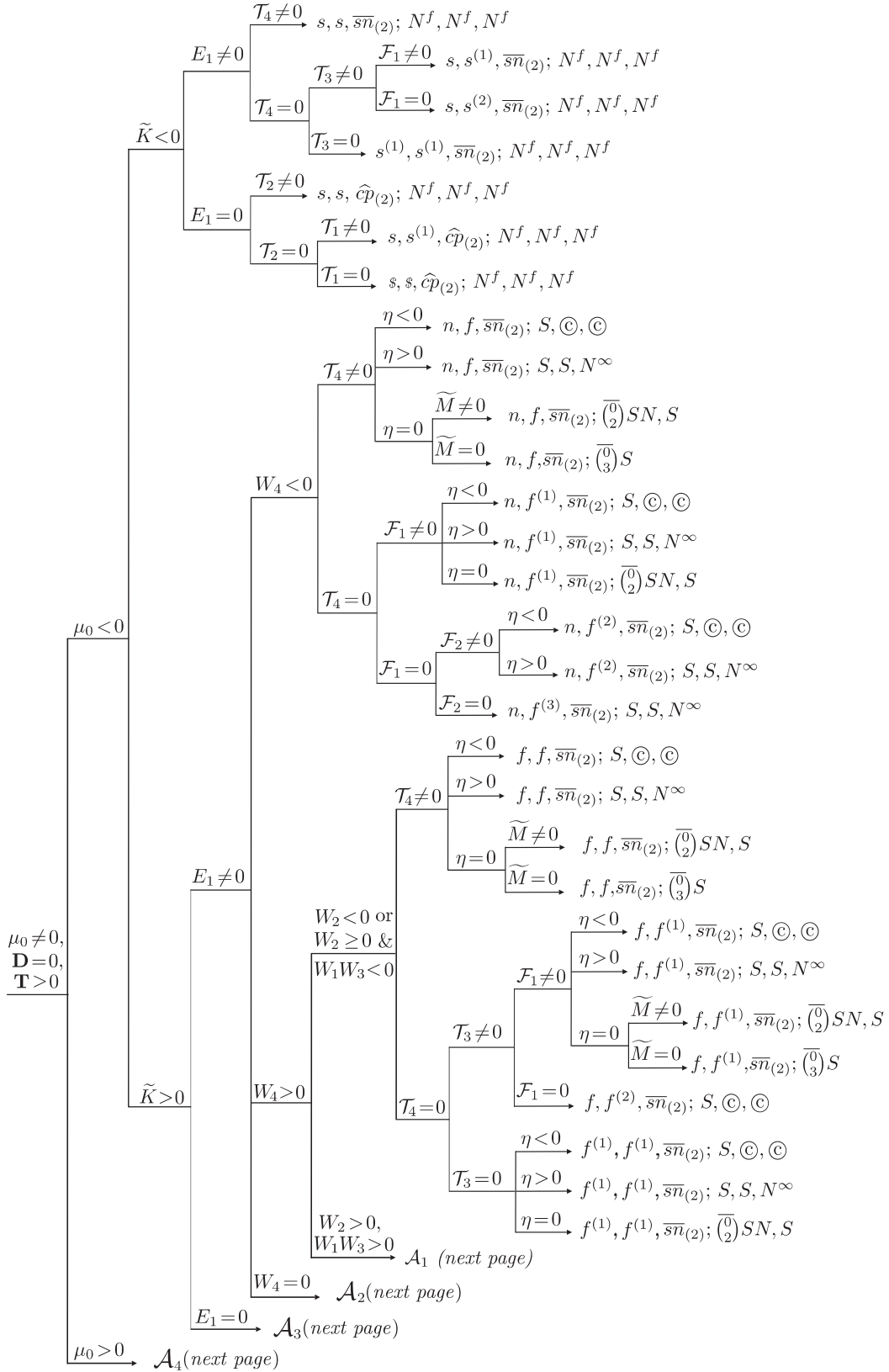
Diagram 1.2: Global configurations: the case $\mu_0 \neq 0, \mathbf{D} = 0, \mathbf{T} < 0$.

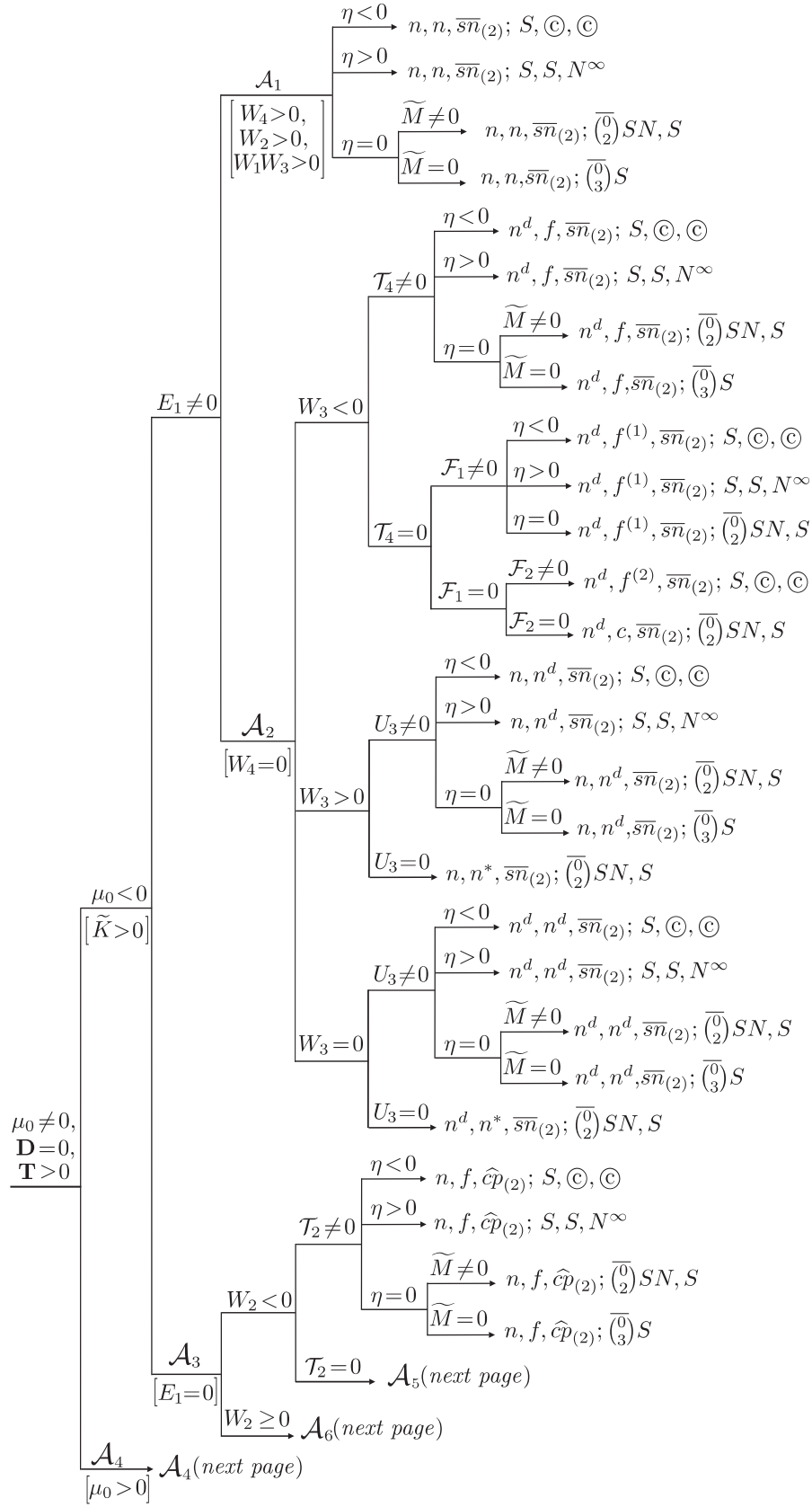
Diagram 1.2 (continued): Global configurations: the case $\mu_0 \neq 0, \mathbf{D} = 0, \mathbf{T} < 0$.

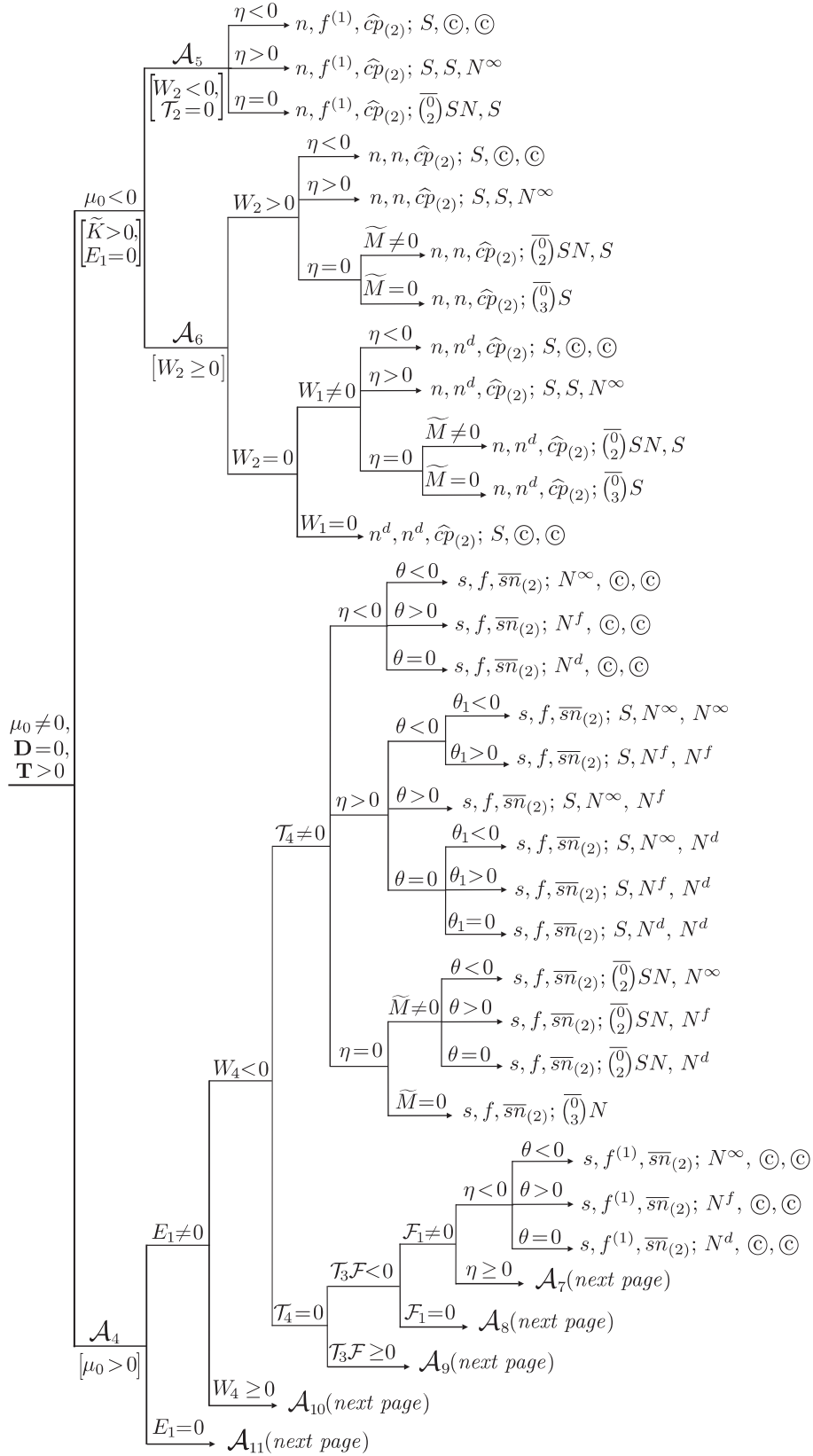
Diagram 1.2 (continued): Global configurations: the case $\mu_0 \neq 0, \mathbf{D} = 0, \mathbf{T} < 0$.

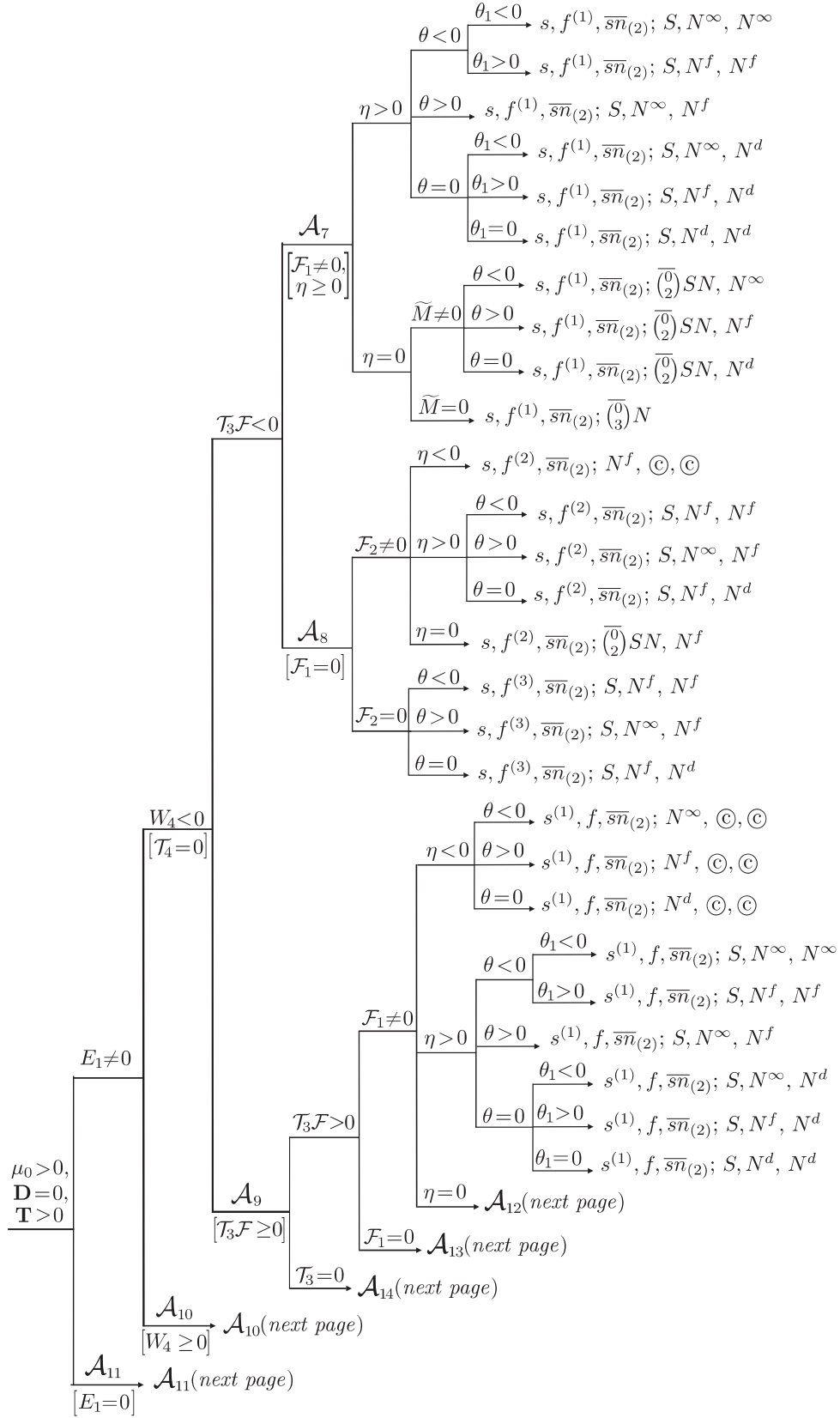
Diagram 1.2 (continued): Global configurations: the case $\mu_0 \neq 0, \mathbf{D} = 0, \mathbf{T} < 0$.

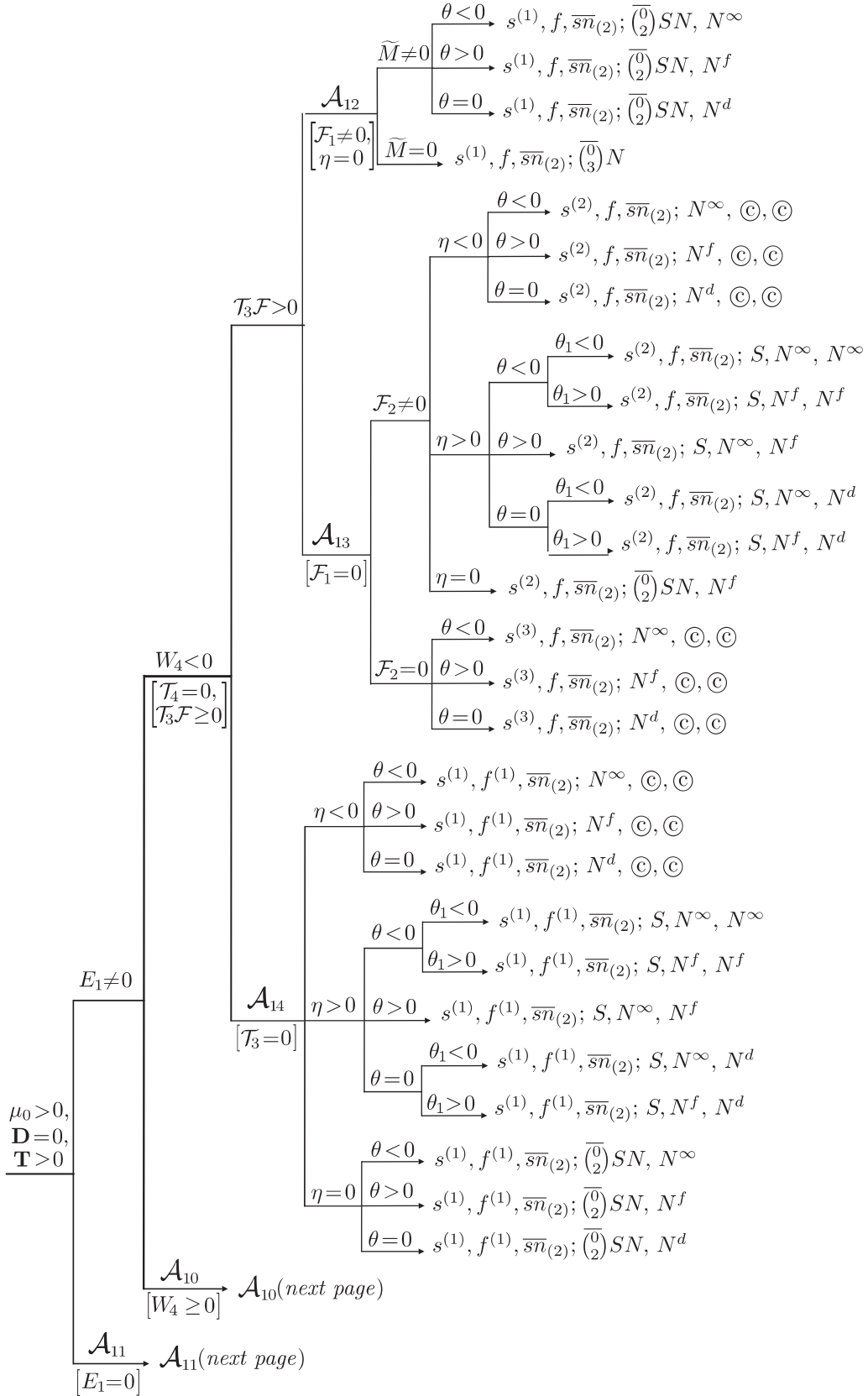
Diagram 1.2 (continued): Global configurations: the case $\mu_0 \neq 0, \mathbf{D} = 0, \mathbf{T} < 0$.

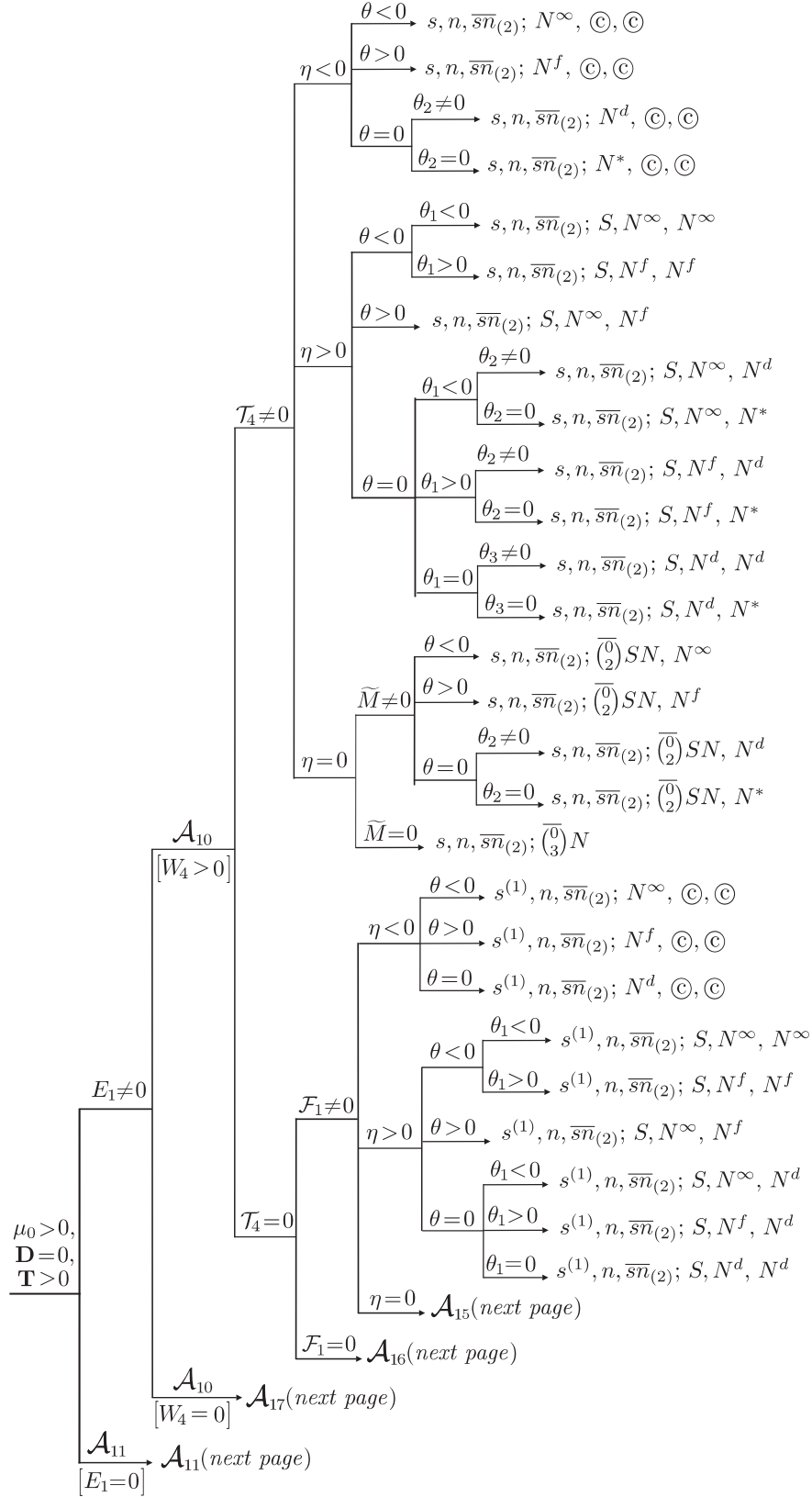
Diagram 1.2 (continued): Global configurations: the case $\mu_0 \neq 0, \mathbf{D} = 0, \mathbf{T} < 0$.

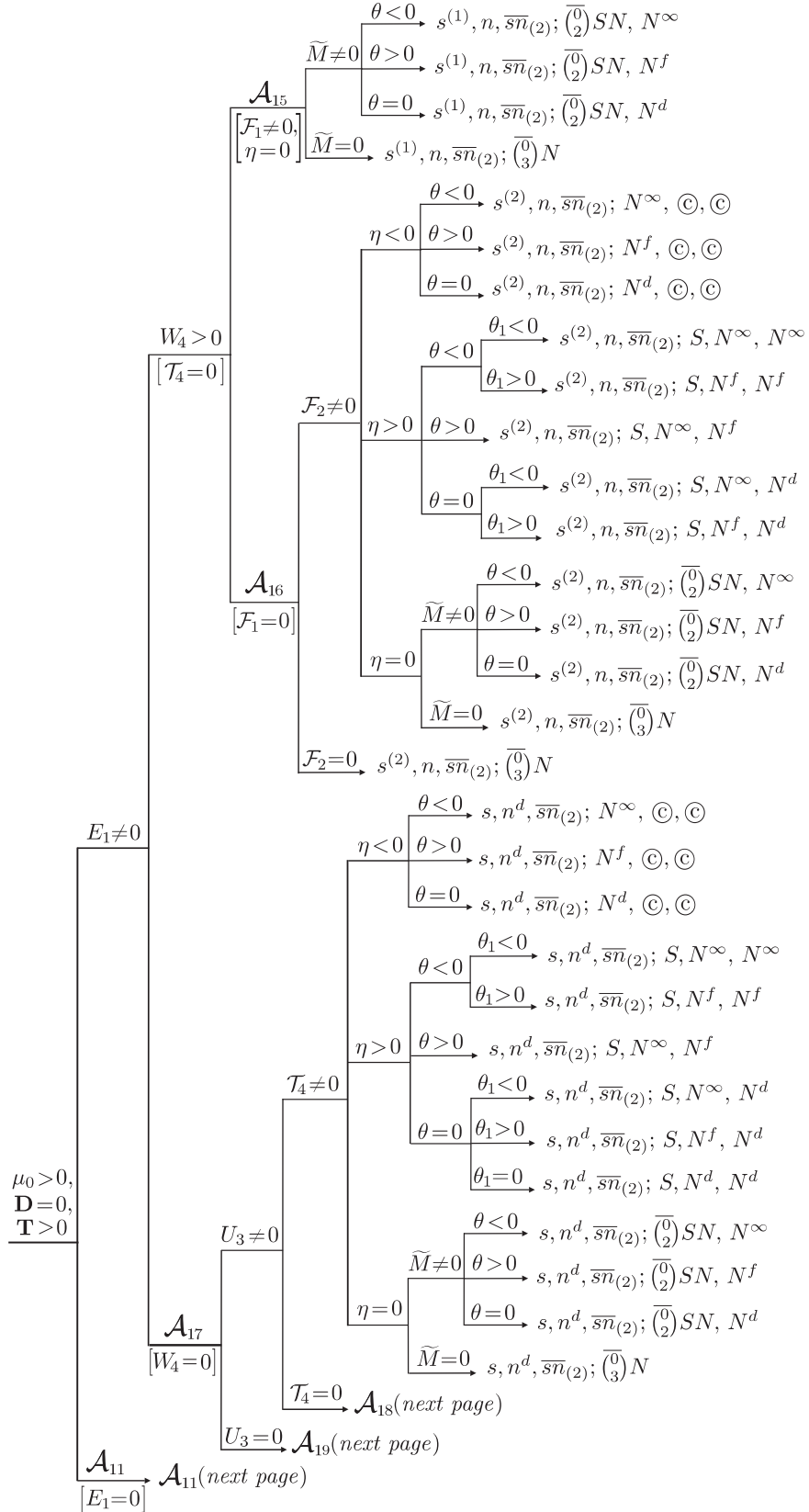
Diagram 1.2 (continued): Global configurations: the case $\mu_0 \neq 0, \mathbf{D} = 0, \mathbf{T} < 0$.

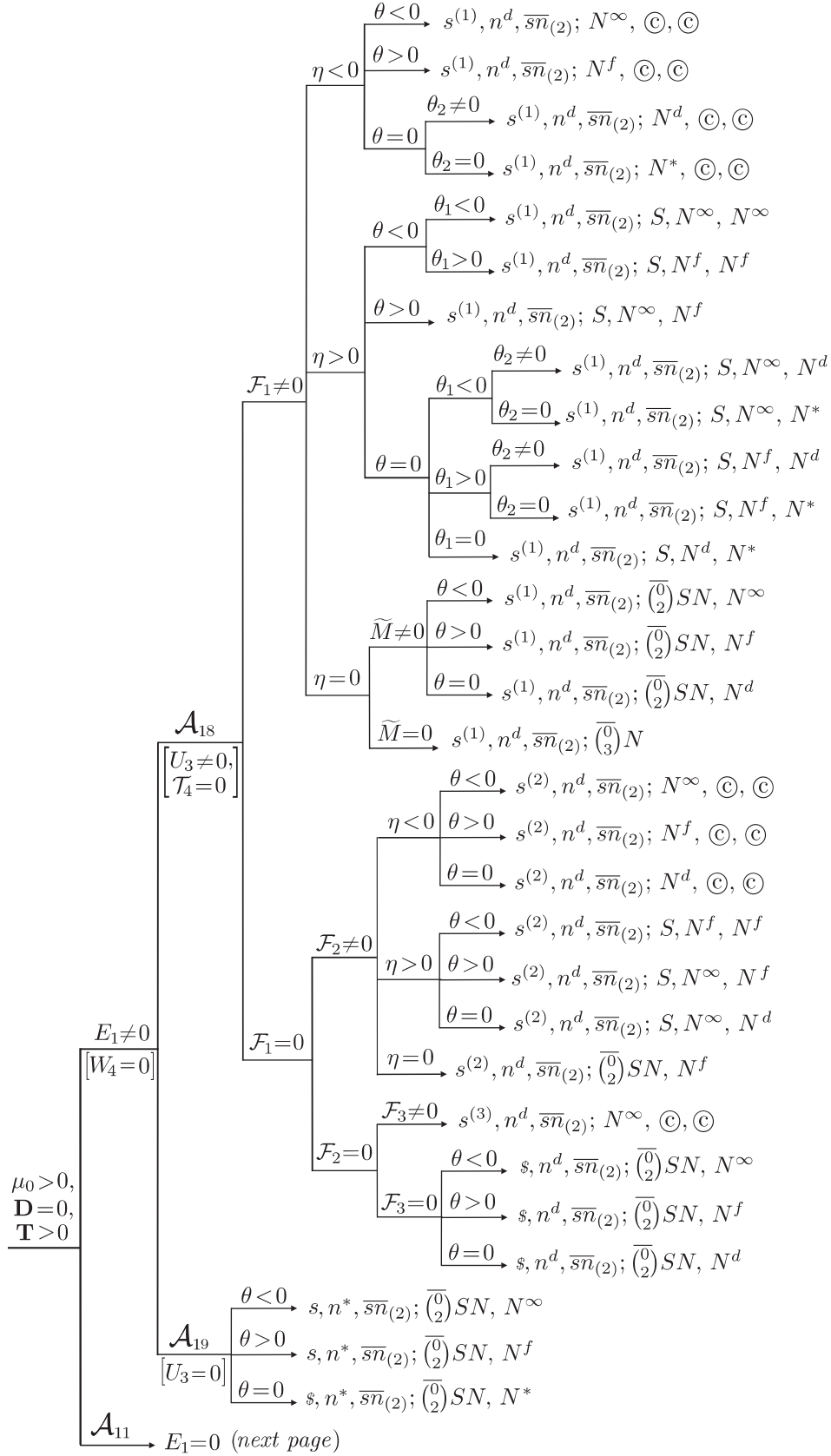
Diagram 1.2 (continued): Global configurations: the case $\mu_0 \neq 0, \mathbf{D} = 0, \mathbf{T} < 0$.

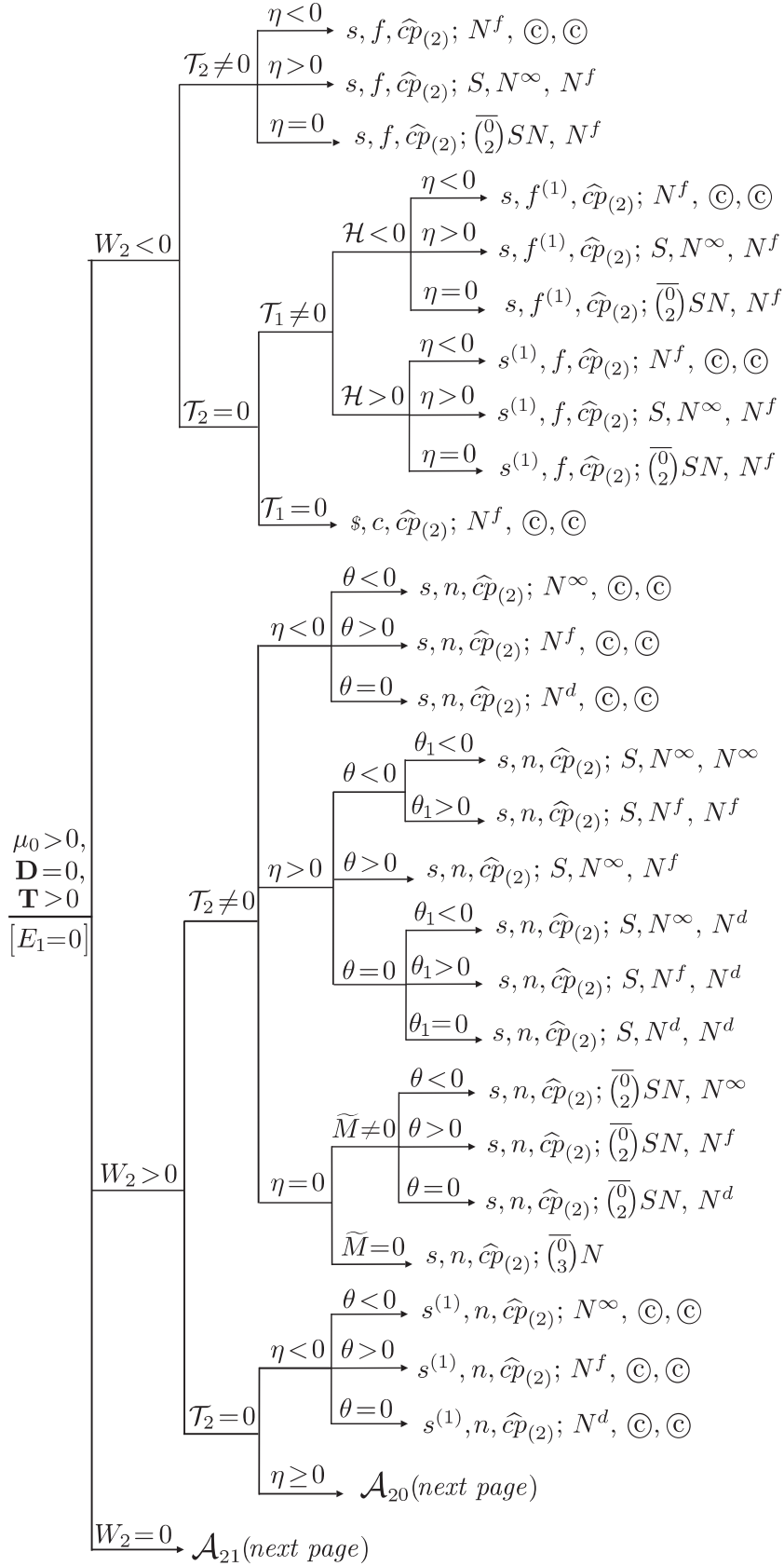
Diagram 1.2 (continued): Global configurations: the case $\mu_0 \neq 0, \mathbf{D} = 0, \mathbf{T} < 0$.

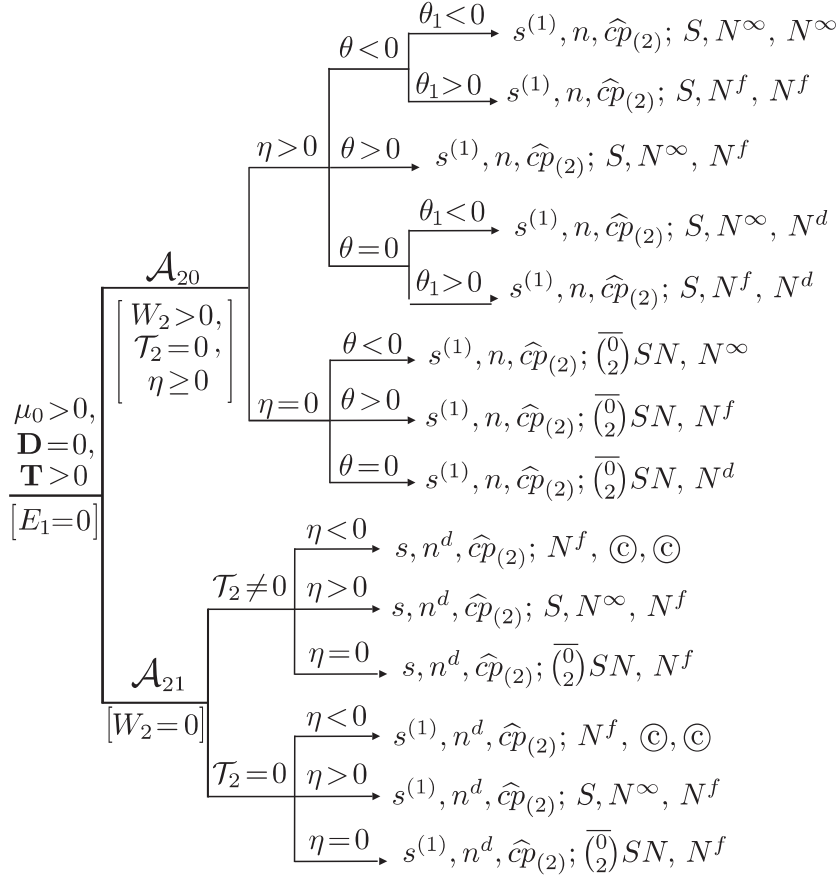
Diagram 1.2 (continued): **Global configurations: the case $\mu_0 \neq 0, \mathbf{D} = 0, \mathbf{T} < 0$.**

The vertical projection of this vector field defined on the upper hemisphere and completed with the equator, yields a diffeomorphic vector field on the unit disk, called the *Poincaré compactification on the disk* of the polynomial differential system. By a *singular point at infinity* of a planar polynomial vector field we mean a singular point of the vector field on the sphere, which is located on the equator of the sphere, also located on the boundary circle of the Poincaré disk.

2.2 Compactification on the projective plane

For a polynomial differential system (1.1) of degree m with real coefficients we associate the differential equation $\omega_1 = q(x, y)dx - p(x, y)dy = 0$. This equation defines two foliations with singularities, one on the real and one on the complex affine planes. We can compactify these foliations with singularities on the real respectively complex projective plane with homogeneous coordinates X, Y, Z . This is done as follows: Consider the pull-back of the form ω_1 via the map $r: K^3 \setminus \{Z = 0\} \rightarrow K^2$ defined by $r(X, Y, Z) = (X/Z, Y/Z)$. We obtain a form $r^*(\omega_1) = \tilde{\omega}$ which has poles on $Z = 0$. Eliminating the denominators in the equation $\tilde{\omega} = 0$ we obtain an equation $\omega = 0$ of the form $\omega = A(X, Y, Z)dX + B(X, Y, Z)dY + C(X, Y, Z)dZ = 0$ with A, B, C homogeneous polynomials of the same degree. The equation $\omega = 0$ defines a foliation with singularities on $P_2(K)$ which, via the map $(x, y) \rightarrow [x : y : 1]$, extends the foliation with singularities, given by $\omega_1 = 0$ on K^2 to a foliation with singularities on $P_2(K)$ which we call the compactification on the projective plane of the foliation with

singularities defined by $\omega_1 = 0$ on the affine plane K^2 (K equal to \mathbb{R} or \mathbb{C}). This is because A, B, C are homogeneous polynomials over K , defined by $A(X, Y, Z) = ZQ(X, Y, Z)$, $Q(X, Y, Z) = Z^m q(X/Z, Y/Z)$, $B(X, Y, Z) = ZP(X, Y, Z)$, $P(X, Y, Z) = Z^m p(X/Z, Y/Z)$ and $C(X, Y, Z) = YP(X, Y, Z) - XQ(X, Y, Z)$. The *points at infinity* of the foliation defined by $\omega_1 = 0$ on the affine plane are the singular points of the type $[X : Y : 0] \in P_2(\mathbb{K})$ and the line $Z = 0$ is called the *line at infinity* of this foliation. The singular points of the foliation on $P_2(K)$ are the solutions of the three equations $A = 0, B = 0, C = 0$. In view of the definitions of A, B, C it is clear that the singular points at infinity are the points of intersection of $Z = 0$ with $C = 0$. For more details see [18], or [2] or [3].

2.3 Assembling multiplicities of singularities in divisors of the line at infinity and in zero-cycles of the plane

An isolated singular point p at infinity of a polynomial vector field of degree n has two types of multiplicities: the maximum number m of finite singularities which can split from p , in small perturbations of the system within polynomial systems of degree n , and the maximum number m' of infinite singularities which can split from p , in small such perturbations of the system. We encode the two in the column $(m, m')^t$. We then encode the global information about all isolated singularities at infinity using formal sums called *cycles* and *divisors* as defined in [20] or in [18] and used in [2, 3, 18, 25].

We have two formal sums (*divisors on the line at infinity* $Z = 0$ of the complex affine plane) $D_S(P, Q; Z) = \sum_w I_w(P, Q)w$ and $D_S(C, Z) = \sum_w I_w(C, Z)w$ where $w \in \{Z = 0\}$ and where by $I_w(F, G)$ we mean the intersection multiplicity at w of the curves $F(X, Y, Z) = 0$ and $G(X, Y, Z) = 0$ on the complex projective plane. For more details see [18]. Following [25] we encode the above two divisors on the line at infinity into just one but with values in the ring \mathbb{Z}^2 :

$$D_S = \sum_{w \in \{Z=0\}} \begin{pmatrix} I_w(P, Q) \\ I_w(C, Z) \end{pmatrix} w.$$

For a system (1.1) with isolated finite singularities we consider the formal sum (*zero-cycle on the plane*) $D_S(p, q) = \sum_{w \in \mathbb{R}^2} I_w(p, q)w$ encoding the multiplicities of all finite singularities. For more details see [18], [1].

2.4 Some geometrical concepts

Firstly we recall some terminology.

We call *elemental* a singular point with its both eigenvalues not zero.

We call *semi-elemental* a singular point with exactly one of its eigenvalues equal to zero.

We call *nilpotent* a singular point with both its eigenvalues zero but with its Jacobian matrix at this point not identically zero.

We call *intricate* a singular point with its Jacobian matrix identically zero.

The *intricate* singularities are usually called in the literature *linearly zero*. We use here the term *intricate* to indicate the rather complicated behavior of phase curves around such a singularity.

In this section we use the same concepts we considered in [2–4, 6], such as *orbit γ tangent to a semi-line L at p* , *well defined angle at p* , *characteristic orbit at a singular point p* , *characteristic*

angle at a singular point, characteristic direction at p . If a singular point has an infinite number of characteristic directions, we will call it a *star-like point*.

It is known that the neighborhood of any isolated singular point of a polynomial vector field, which is not a focus or a center, is formed by a finite number of sectors which could only be of three types: parabolic, hyperbolic and elliptic (see [15]). It is also known that any degenerate singular point can be desingularized by means of a finite number of changes of variables, called blowups, into elemental and semi-elemental singular points (for more details see the section on blowup in [2] or [15]).

Topologically equivalent local phase portraits can be distinguished according to the algebraic properties of their phase curves. For example they can be distinguished algebraically in the case when the singularities possess distinct numbers of characteristic directions.

The usual definition of a sector is of topological nature and it is local, defined with respect to a neighborhood around the singular point. We work with a new notion, namely of *geometric local sector*, introduced in [2], based on the notion of *borsec*, term meaning "border of a sector" (a new kind of sector, i.e. *geometric sector*) which takes into account orbits tangent to the half-lines of the characteristic directions at a singular point. For example a generic or semi-elemental node p has two characteristic directions generating four half lines at p . For each one of these half lines at p there exists at least one orbit tangent to that half line at p and we pick such an orbit (one for each half line). Removing these four orbits together with the singular point, we are left with four sectors which we call *geometric local sectors* and we call *borsecs* these four orbits. The notion of *geometric local sector* and of *borsec* was extended for nilpotent and intricate singular points using the process of desingularization as indicated in [4]. We end up with the following definition: We call *geometric local sector* of a singular point p with respect to a sufficiently small neighborhood V , a region in V delimited by two consecutive borsecs. As already mentioned these are defined using the desingularization process.

A nilpotent or intricate singular point can be desingularized by passing to polar coordinates or by using rational changes of coordinates. The first method has the inconvenience of using trigonometrical functions, and this becomes a serious problem when a chain of blowups are needed in order to complete the desingularization of the degenerate point. The second uses rational changes of coordinates, convenient for our polynomial systems. In such a case two blowups in different directions are needed and information from both must be glued together to obtain the desired portrait.

Here for desingularization we use the second possibility, namely with rational changes of coordinates at each stage of the process. Two rational changes are needed, one for each direction of the blow-up. If at a stage the coordinates are (x, y) and we do a blow-up of a singular point in y -direction, this means that we introduce a new variable z and consider the diffeomorphism of the (x, y) plane for $x \neq 0$ defined by $\phi(x, y) = (x, y, z)$ where $y = xz$. This diffeomorphism transfers our vector field on the subset $x \neq 0$ of the plane (x, y) on the subset $x \neq 0$ of the algebraic surface $y = zx$. It can easily be checked that the projection $(x, xz, z) \mapsto (x, z)$ of this surface on the (x, z) plane is a diffeomorphism. So our vector field on the plane (x, y) for $x \neq 0$ is diffeomorphic via the map $(x, y) \mapsto (x, y/x) = (x, z)$ for $x \neq 0$ to the vector field thus obtained on the (x, z) plane for $x \neq 0$. The point $p = (0, 0)$ is then replaced by the straight line $x = 0 = y$ in the 3-dimensional space of coordinates x, y, z . This line is also the z -axis of the plane (x, z) and it is called *blow-up line*.

The two directional blowups can be reduced to only one 1-direction blowup but making sure that the direction in which we do a blowup is not a characteristic direction, not to lose information by blowing up in the chosen direction. This can be easily solved by a simple

linear change of coordinates of the type $(x, y) \rightarrow (x + ky, y)$ where k is a constant (usually 1). It seems natural to call this linear change a k -twist as the y -axis gets turned with some angle depending on k . It is obvious that the phase portrait of the degenerate point which is studied cannot depend on the values of k 's used in the desingularization process.

We recall that after a complete desingularization all singular points are elemental or semi-elemental. For more details and a complete example of the desingularization of an intricate singular point see [4].

Generically a *geometric local sector* is defined by two consecutive borsecs arriving at the singular point with two different well defined angles. If this sector is parabolic, then the solutions can arrive at the singular point with one of the two characteristic angles, and this is a geometric information that can be revealed with the blowup.

There is also the possibility that two borsecs defining a geometric local sector at a point p are tangent to the same half-line at p . Such a sector will be called a *cusplike sector* which can either be hyperbolic, elliptic or parabolic denoted by H_λ , E_λ and P_λ respectively. In the case of parabolic sectors we want to include the information about how the orbits arrive at the singular points namely tangent to one or to the other borsec. We distinguish the two cases by writing \hat{P} if they arrive tangent to the borsec limiting the previous sector in clockwise sense, or \hat{P} if they arrive tangent to the borsec limiting the next sector. In the case of a cusplike parabolic sector, all orbits must arrive with only one well determined angle, but the distinction between \hat{P} and \hat{P} is still valid because it occurs at some stage of the desingularization and this can be algebraically determined. Example of descriptions of complicated intricate singular points are $\hat{P}E\hat{P}HHH$ and $E\hat{P}_\lambda HH\hat{P}_\lambda E$.

A star-like point can either be a node or something much more complicated with elliptic and hyperbolic sectors included. In case there are hyperbolic sectors, they must be cusplike. Elliptic sectors can either be cusplike, or star-like.

2.5 Notations for singularities of polynomial differential systems

In this work we limit ourselves to the class of quadratic systems with finite singularities of total multiplicity four and exactly three singularities. In [2] we introduced convenient notations which we also used in [3–6] some of which we also need here. Because these notations are essential for understanding the bifurcation diagram, we indicate below the notations necessary for this article.

The finite singularities will be denoted by small letters and the infinite ones by capital letters. In a sequence of singular points we always place the finite ones first and then infinite ones, separating them by a semicolon ';'.

Elemental points: We use the letters 's', 'S' for "saddles"; \$ for "integrable saddles"; 'n', 'N' for "nodes"; 'f' for "foci"; 'c' for "centers" and © (respectively ©) for complex finite (respectively infinite) singularities. We distinguish the finite nodes as follows:

- 'n' for a node with two distinct eigenvalues (generic node);
- 'n^d' (a one-direction node) for a node with two identical eigenvalues whose Jacobian matrix is not diagonal;
- 'n*' (an star node) for a node with two identical eigenvalues whose Jacobian matrix is diagonal.

The case n^d (and also n^*) corresponds to a real finite singular point with zero discriminant.

In the case of an elemental infinite generic node, we want to distinguish whether the eigenvalue associated to the eigenvector directed towards the affine plane is, in absolute value, greater or lower than the eigenvalue associated to the eigenvector tangent to the line at infinity. This is relevant because this determines if on the Poincaré disk all the orbits except one arrive at infinity tangent to the line at infinity or transversal to this line. We will denote them as ' N^∞ ' and ' N^f ' respectively.

Finite elemental foci and saddles are classified as strong or weak foci, respectively strong or weak saddles. The strong foci or saddles are those with non-zero trace of the Jacobian matrix evaluated at them. In this case we denote them by ' s ' and ' f '. When the trace is zero, except for centers, and saddles of infinite order (i.e. with all their Poincaré–Lyapunov constants equal to zero), it is known that the foci and saddles, in the quadratic case, may have up to 3 orders. We denote them by ' $f^{(i)}$ ' and ' $s^{(i)}$ ' where $i = 1, 2, 3$ is the order. In addition we have the centers which we denote by ' c ' and saddles of infinite order (integrable saddles) which we denote by ' s '.

Foci and centers cannot appear as singular points at infinity and hence there is no need to introduce their order in this case. In case of saddles, we can have weak saddles at infinity but the maximum order of weak singularities in cubic systems is not yet known. For this reason, a complete study of weak saddles at infinity cannot be done at this stage. Due to this, in [2–7] and here we chose not even to distinguish between a saddle and a weak saddle at infinity.

All non-elemental singular points are multiple points, in the sense that there are perturbations which have at least two elemental singular points as close as we wish to the multiple point. For finite singular points we denote with a subindex their multiplicity as in ' $\bar{s}_{(5)}$ ' or in ' $\widehat{es}_{(3)}$ ' (the notation ' $\widehat{}$ ' indicates that the saddle is semi-elemental and ' $\bar{}$ ' indicates that the singular point is nilpotent, in this case a triple *elliptic saddle*, i.e. it has two sectors, one elliptic and one hyperbolic). In order to describe the two kinds of multiplicity for infinite singular points we use the concepts and notations introduced in [25]. Thus we denote by ' $\binom{a}{b}$ '... the maximum number a (respectively b) of finite (respectively infinite) singularities which can be obtained by perturbation of the multiple point. For example ' $\binom{1}{1}SN$ ' means a saddle–node at infinity produced by the collision of one finite singularity with an infinite one; ' $\binom{0}{3}S$ ' means a saddle produced by the collision of 3 infinite singularities.

Semi-elemental points: They can either be nodes, saddles or saddle–nodes, finite or infinite (see [15]). We denote the semi-elemental ones always with an overline, for example ' \overline{sn} ', ' \overline{s} ' and ' \overline{n} ' with the corresponding multiplicity. In the case of infinite points we put ' $\widehat{}$ ' on top of the parenthesis with multiplicities.

Semi-elemental nodes could never be ' n^d ' or ' n^* ' since their eigenvalues are always different. In case of an infinite semi-elemental node, the type of collision determines whether the point is denoted by ' N^f ' or by ' N^∞ '. The point ' $\binom{2}{1}N$ ' is an ' N^f ' and ' $\binom{0}{3}N$ ' is an ' N^∞ '.

There do not exist finite or infinite nilpotent points and neither do there exist intricate points when $m_f = 4$ and there are three finite distinct singularities. Neither is it possible to have the line at infinity filled up with singularities. For this reason we skip the notations of these points in this paper. We refer the interested reader to [2–7].

2.6 Affine invariant polynomials and preliminary results

Consider real quadratic systems of the form

$$\begin{aligned}\frac{dx}{dt} &= p_0 + p_1(x, y) + p_2(x, y) \equiv P(x, y), \\ \frac{dy}{dt} &= q_0 + q_1(x, y) + q_2(x, y) \equiv Q(x, y),\end{aligned}\tag{2.1}$$

with homogeneous polynomials p_i and q_i ($i = 0, 1, 2$) in x, y which are defined as follows:

$$\begin{aligned}p_0 &= a_{00}, & p_1(x, y) &= a_{10}x + a_{01}y, & p_2(x, y) &= a_{20}x^2 + 2a_{11}xy + a_{02}y^2, \\ q_0 &= b_{00}, & q_1(x, y) &= b_{10}x + b_{01}y, & q_2(x, y) &= b_{20}x^2 + 2b_{11}xy + b_{02}y^2.\end{aligned}$$

Let $\tilde{a} = (a_{00}, a_{10}, a_{01}, a_{20}, a_{11}, a_{02}, b_{00}, b_{10}, b_{01}, b_{20}, b_{11}, b_{02})$ be the 12-tuple of the coefficients of systems (2.1) and denote $\mathbb{R}[\tilde{a}, x, y] = \mathbb{R}[a_{00}, \dots, b_{02}, x, y]$.

It is known that on the set \mathbf{QS} of all quadratic differential systems (2.1) acts the group $\text{Aff}(2, \mathbb{R})$ of affine transformations on the plane (cf. [25]). For every subgroup $G \subseteq \text{Aff}(2, \mathbb{R})$ we have an induced action of G on \mathbf{QS} . We can identify the set \mathbf{QS} of systems (2.1) with a subset of \mathbb{R}^{12} via the map $\mathbf{QS} \rightarrow \mathbb{R}^{12}$ which associates to each system (2.1) the 12-tuple $\tilde{a} = (a_{00}, \dots, b_{02})$ of its coefficients. We associate to this group action polynomials in x, y and parameters which behave well with respect to this action, the GL -comitants, the T -comitants and the CT -comitants. For their constructions we refer the reader to the paper [25] (see also [26]). In the statement of our main theorem intervene invariant polynomials constructed in these articles and which could also be found on the following associated web page:

<http://mat.uab.es/~artés/articles/qvfinvariants/qvfinvariants.html>

We shall need the next result.

Lemma 2.1 ([22]). *Consider the equation*

$$az^4 + 4bz^3 + 6cz^2 + 4dz + e = 0$$

and the associated polynomials:

$$\begin{aligned}\hat{P} &= ae - 4bd + 3c^2, & \hat{Q} &= (b^2 - ac)e + ad^2 + (c^2 - 2bd)c, & \hat{D} &= 27\hat{Q}^2 - \hat{P}^3, \\ \hat{R} &= b^2 - ac, & \hat{S} &= 12\hat{R}^2 - a^2\hat{P}, & \hat{T} &= 3a\hat{Q} = 2\hat{P}\hat{R}, & \hat{U} &= 2d^2 - 3ce.\end{aligned}$$

These polynomials completely determine the number of distinct roots, real and complex, and their multiplicities. More precisely, in the case $a \neq 0$ we have:

- 4 real simple roots $\Leftrightarrow \hat{D} < 0, \hat{R} > 0, \hat{S} > 0$;
- 2 real and 2 complex simple roots $\Leftrightarrow \hat{D} > 0$;
- 4 complex simple roots $\Leftrightarrow \hat{D} < 0$ and either $\hat{R} \leq 0$ or $\hat{S} < 0$;
- 3 real roots, 1 double and 2 simple $\Leftrightarrow \hat{D} = 0, \hat{T} < 0$;
- 1 real double and 2 complex simple roots $\Leftrightarrow \hat{D} = 0, \hat{T} > 0$;
- 2 real roots, 1 triple and 1 simple $\Leftrightarrow \hat{D} = \hat{P} = 0, \hat{R} \neq 0$;
- 2 real roots both double $\Leftrightarrow \hat{D} = \hat{T} = 0, \hat{P}\hat{R} > 0$;
- 2 complex roots, both double $\Leftrightarrow \hat{D} = \hat{T} = 0, \hat{P}\hat{R} < 0$;
- 1 real root of multiplicity 4 $\Leftrightarrow \hat{D} = \hat{P} = \hat{R} = 0$.

3 The proof of the Main theorem

Our proof is based on previous work done in [8] where the study of finite singularities of quadratic differential systems was done, on [2] where we studied the infinite singularities of these systems and on [28] where the characterization of weak finite singularities was done, characterization missing in [8], and where also all the canonical forms for studying singularities of quadratic systems are described.

The idea of the proof is to follow the steps taken in these papers for the specific case we consider here, unifying the part for the finite singularities in [8] with the part for the infinite singularities in [2], while adding also the information about weak finite singularities in [28].

This combinatorial work leads to a large number of combinations of potential geometric configurations of singularities. It remains to show which of these are actually realizable and which ones are to be discarded.

These combinations are characterized in terms of equalities and inequalities among polynomials over \mathbb{R} in the coefficients of the systems. Proceeding by trial and error we produce examples when the conditions can be realized. When several such trials are unsuccessful, suspecting the conditions expressed in terms of invariant polynomials cannot be realized, we then look for a proof that the conditions are contradictory and in this case that combination is discarded from the list.

Such contradictions can occur with repetitions and for this reason we thought it best to single out a number of lemmas which were instrumental for discarding un-realizable combinations. These lemmas are of the type “if A then B ” where A and B are conjunctions of equalities and inequalities expressed in terms of above mentioned polynomials.

Consider real quadratic systems (2.1). According to [28] for a quadratic system (2.1) to have finite singularities of total multiplicity four (i.e. $m_f = 4$) the condition $\mu_0 \neq 0$ must be satisfied. We consider here the two subclasses of quadratic differential systems with $m_f = 4$ possessing exactly three finite singularities, namely:

- systems with one double real and two simple complex singularities ($\mu_0 \neq 0$, $\mathbf{D} = 0$, $\mathbf{T} > 0$);
- systems with one double and two simple real finite singularities ($\mu_0 \neq 0$, $\mathbf{D} = 0$, $\mathbf{T} < 0$).

Clearly the systems from each one in the above mentioned subclasses have finite singularities of total multiplicity 4 and therefore by [2] the following lemma is valid.

Lemma 3.1. *The geometric configurations of singularities at infinity of the family of quadratic systems possessing finite singularities of total multiplicity 4 (i.e. $\mu_0 \neq 0$) are classified in Diagram 3.1 according to the geometric equivalence relation. Necessary and sufficient conditions for each one of the 24 different equivalence classes can be assembled from these diagrams in terms of 9 invariant polynomials with respect to the action of the affine group and time rescaling.*

3.1 Systems with one double real and two simple complex singularities

Assume that systems (2.1) have one real double and two simple complex finite singularities. In this case according to [28] we shall consider the family of systems

$$\begin{aligned} \dot{x} &= cmx + 2cny + gx^2 - 2cny + (g + cm)y^2, \\ \dot{y} &= emx + 2eny + lx^2 - 2enxy + (l + em)y^2, \end{aligned} \tag{3.1}$$

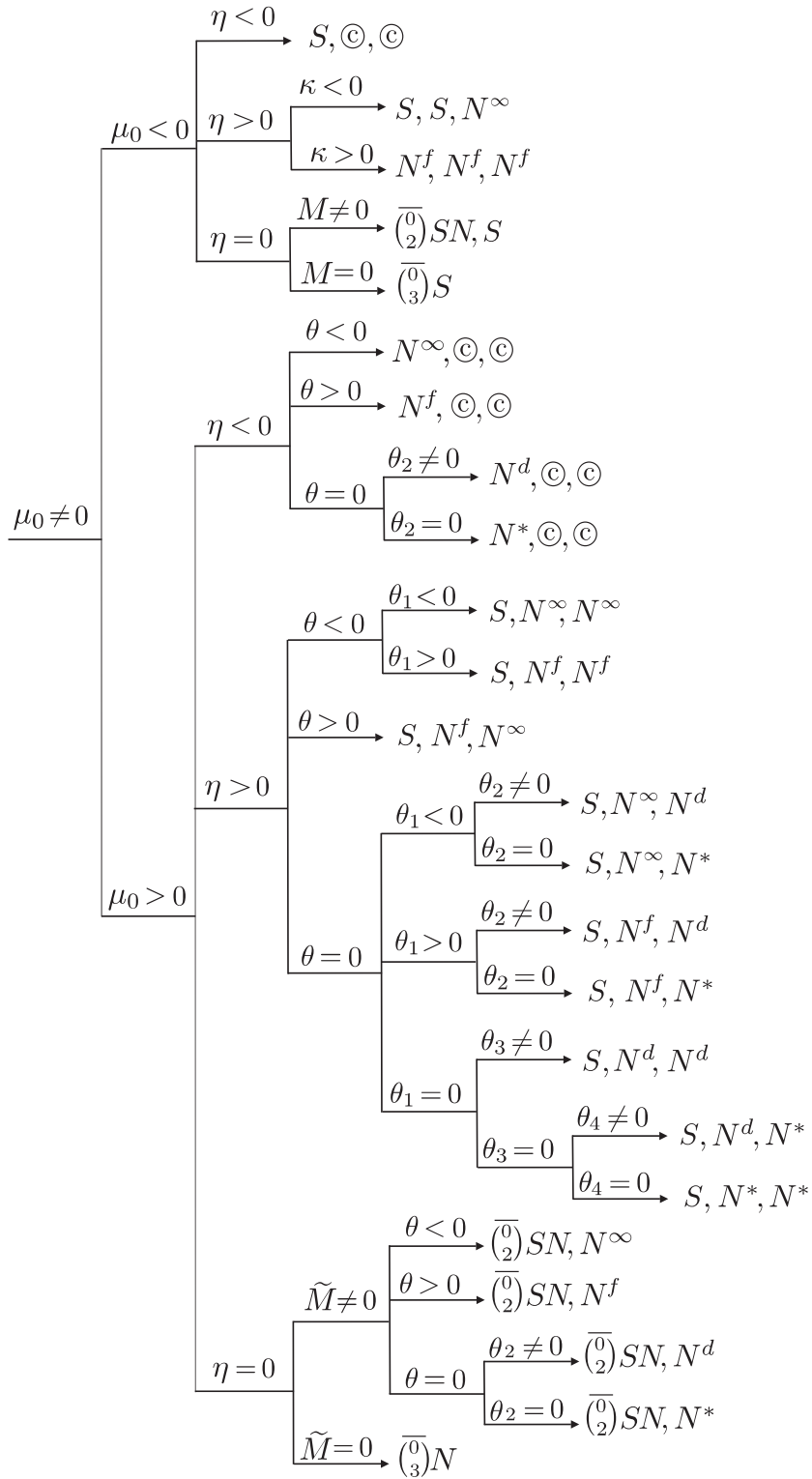

Diagram 3.1: Configurations of infinite singularities: the case $\mu_0 \neq 0$.

with $(cl - eg)(m^2 + 4n^2) \neq 0$, possessing the following three distinct singularities: $M_{1,2}(0,0)$ (double), $M_{3,4}(1, \pm i)$.

We observe that for this family of systems we have

$$\mu_0 = (cl - eg)^2(m^2 + 4n^2), \quad E_1 = 2(cl - eg)^4(cm + 2en)(m^2 + 4n^2)^2 \quad (3.2)$$

and hence $\mu_0 > 0$. On the other hand according to [8] the double point is a saddle-node if $E_1 \neq 0$ and it is a cusp if $E_1 = 0$.

Lemma 3.2. *if for a system (3.1) the conditions $\theta = E_1 = \theta_1\theta_2 = 0$ hold, then $\theta_1 = \theta_2 = 0$, $\eta > 0$ and $\theta_3 \neq 0$.*

Proof. We claim that the hypotheses of the lemma imply $n \neq 0$. Indeed, assuming $n = 0$ we calculate for systems (3.1)

$$\mu_0 = m^2(cl - eg)^2, \quad E_1 = 2cm^5(cl - eg)^4.$$

Therefore the condition $E_1 = 0$ implies $c = 0$ and then we have

$$\mu_0 = e^2g^2m^2 \neq 0, \quad \theta = -64eg^2lm = 0.$$

So we get $l = 0$ and we calculate $\theta_1 = -64g^4$ and $\theta_2 = -eg^2m^2$. Clearly $\theta_1\theta_2 \neq 0$ (due to $\mu_0 \neq 0$) and this proves our claim.

Thus $n \neq 0$ and we may assume $n = 1$ due to a time rescaling and considering (3.2) we deduce that the condition $E_1 = 0$ implies $e = -cm/2$. Then calculations yield

$$\begin{aligned} \theta &= 8c(2l + gm)(4c^2 - 4g^2 + 8cl + 4l^2 + 4glm + c^2m^2 + 2clm^2), \\ \mu_0 &= c^2(2l + gm)^2(4 + m^2)/4 \end{aligned}$$

and due to $\mu_0 \neq 0$ the condition $E_1 = 0$ implies $c = -l \pm (lm - 2g)/\sqrt{4 + m^2}$. We calculate

$$\begin{aligned} \theta_1 &= -32(2l + gm)^3(lm - 2g)(m \pm \sqrt{4 + m^2})/(4 + m^2), \\ \theta_2 &= -(2l + gm)(lm - 2g)[2g + l(-m \pm \sqrt{4 + m^2})](4 + m^2 \mp m\sqrt{4 + m^2})/(4 + m^2), \\ \mu_0 &= (2l + gm)^2[2g + l(-m \pm \sqrt{4 + m^2})]^2/4. \end{aligned}$$

We observe that $(m \pm \sqrt{4 + m^2})(4 + m^2 \mp m\sqrt{4 + m^2}) \neq 0$ (we have only complex roots) and therefore due to $\mu_0 \neq 0$ we get that $\theta_1 = 0$ is equivalent to $\theta_2 = 0$ and this implies $g = lm/2$. Then we calculate

$$\eta = c^4(4 + m^2)^3/16 = \mu_0, \quad \theta_3 = c^6(4 + m^2)^4/32$$

and since $\mu_0 \neq 0$ we get $\theta_3 \neq 0$ and $\eta > 0$. This completes the proof of the lemma. \square

Lemma 3.3. *Systems (3.1) could not possess two star nodes at infinity.*

Proof. Suppose the contrary that we have two star nodes at infinity. According to [2] a quadratic system possesses two infinite star nodes if and only if $\theta = \theta_1 = \theta_3 = \theta_4 = 0$. It is clear that in this case there must be three real singularities at infinity and by [2, Lemma 1] via a linear transformation and a time rescaling systems (2.1) could be brought to the canonical systems (S_I) , where we can assume that the star nodes are the origins of the infinite local charts. Then following [2] we determine that the corresponding linear matrices in these local charts are

$$R_1 \Rightarrow \begin{pmatrix} 1 & -e \\ 0 & g \end{pmatrix}; \quad R_2 \Rightarrow \begin{pmatrix} 1 & -d \\ 0 & h \end{pmatrix}.$$

Therefore we obtain that the above conditions imply, for the canonical form mentioned, the relations: $g - 1 = h - 1 = e = d = 0$ and we get the systems

$$\dot{x} = a + cx + x^2, \quad \dot{y} = b + fy + y^2.$$

For these systems we calculate

$$\begin{aligned}\mu_0 &= 1, & \mathbf{D} &= -48(4a - c^2)^2(4b - f^2)^2, \\ \mathbf{T} &= 6(4a - c^2)(4b - f^2)x^2y^2(4bx^2 - f^2x^2 + 4ay^2 - c^2y^2)\end{aligned}$$

and therefore the condition $\mathbf{D} = 0$ implies $\mathbf{T} = 0$. However according to [8] a quadratic system possesses one double real and two complex singularities if and only if $\mu_0 \neq 0$, $\mathbf{D} = 0$ and $\mathbf{T} > 0$. This contradiction completes the proof of the lemma. \square

3.1.1 The case $E_1 \neq 0$

Then the double finite singular point is a semi-elemental saddle-node.

The subcase $\eta < 0$ Then systems (3.1) possess one real and two complex infinite singular points and according to Lemma 3.1 there can be only 4 geometrically distinct configurations at infinity. It remains to construct the corresponding examples:

- $\overline{sn}_{(2), \odot, \odot}; N^\infty, \odot, \odot$: Example \Rightarrow ((3.1) : $c = 1, e = -2, g = 5, l = 0, m = 1, n = 1$) (if $\theta < 0$);
- $\overline{sn}_{(2), \odot, \odot}; N^f, \odot, \odot$: Example \Rightarrow ((3.1) : $c = -1, e = 2, g = 5, l = 0, m = 1, n = 1$) (if $\theta > 0$);
- $\overline{sn}_{(2), \odot, \odot}; N^d, \odot, \odot$: Example \Rightarrow ((3.1) : $c = 1, e = 0, g = -5/2, l = 1, m = 3/2, n = 1$) (if $\theta = 0, \theta_2 \neq 0$);
- $\overline{sn}_{(2), \odot, \odot}; N^*, \odot, \odot$: Example \Rightarrow ((3.1) : $c = 1, e = 0, g = -1, l = 1, m = 1, n = 0$) (if $\theta = 0, \theta_2 = 0$).

The subcase $\eta > 0$ In this case systems (3.1) possess three real infinite singular points. Since for these systems the condition $\mu_0 > 0$ holds, taking into consideration Lemmas 3.3 and 3.1 we can have at infinity only 9 distinct configurations. The corresponding examples are:

- $\overline{sn}_{(2), \odot, \odot}; S, N^\infty, N^\infty$: Example \Rightarrow ((3.1) : $c = 1, e = 1, g = -21/20, l = -3, m = 0, n = 2$) (if $\theta < 0, \theta_1 < 0$);
- $\overline{sn}_{(2), \odot, \odot}; S, N^f, N^f$: Example \Rightarrow ((3.1) : $c = 1, e = 2, g = -1, l = 0, m = 1, n = 1$) (if $\theta < 0, \theta_1 > 0$);
- $\overline{sn}_{(2), \odot, \odot}; S, N^\infty, N^f$: Example \Rightarrow ((3.1) : $c = 1, e = 1, g = -1, l = 0, m = 1, n = 1$) (if $\theta > 0$);
- $\overline{sn}_{(2), \odot, \odot}; S, N^\infty, N^d$: Example \Rightarrow ((3.1) : $c = 1, e = 1, g = -1, l = -3, m = 0, n = 2$) (if $\theta = 0, \theta_1 < 0, \theta_2 \neq 0$);
- $\overline{sn}_{(2), \odot, \odot}; S, N^\infty, N^*$: Example \Rightarrow ((3.1) : $c = 3, e = 1, g = -3, l = -2, m = 1, n = 0$) (if $\theta = 0, \theta_1 < 0, \theta_2 = 0$);
- $\overline{sn}_{(2), \odot, \odot}; S, N^f, N^d$: Example \Rightarrow ((3.1) : $c = 2, e = 1, g = 6, l = 0, m = -3, n = 2$) (if $\theta = 0, \theta_1 > 0, \theta_2 \neq 0$);
- $\overline{sn}_{(2), \odot, \odot}; S, N^f, N^*$: Example \Rightarrow ((3.1) : $c = 1, e = 1, g = 2, l = 1, m = -2, n = 0$) (if $\theta = 0, \theta_1 > 0, \theta_2 = 0$);
- $\overline{sn}_{(2), \odot, \odot}; S, N^d, N^d$: Example \Rightarrow ((3.1) : $c = 1, e = 1, g = -2, l = -1, m = 1, n = 1$) (if $\theta = 0, \theta_1 = 0, \theta_3 \neq 0$);
- $\overline{sn}_{(2), \odot, \odot}; S, N^d, N^*$: Example \Rightarrow ((3.1) : $c = 1, e = 1, g = -1, l = 0, m = 1, n = 0$) (if $\theta = \theta_1 = \theta_3 = 0$).

The subcase $\eta = 0$ In this case systems (3.1) possess at infinity either one double and one simple real singular points (if $\tilde{M} \neq 0$), or one triple real singularity (if $\tilde{M} = 0$). So by Lemma 3.1 we could have at infinity exactly 5 distinct configurations. We have the following 4 configurations:

• $\overline{s\tilde{n}}_{(2)}, \odot, \odot; \binom{0}{2}SN, N^\infty$: Example \Rightarrow ((3.1) : $c = 1, e = 1, g = -1, l = -3, m = 1, n = 1$) (if $\theta < 0$);

• $\overline{s\tilde{n}}_{(2)}, \odot, \odot; \binom{0}{2}SN, N^f$: Example \Rightarrow ((3.1) : $c = 1, e = 1, g = 1, l = -1, m = -1, n = 1$) (if $\theta > 0$);

• $\overline{s\tilde{n}}_{(2)}, \odot, \odot; \binom{0}{2}SN, N^d$: Example \Rightarrow ((3.1) : $c = 1, e = 1, g = 0, l = -2, m = 0, n = 1$) (if $\theta = 0, \theta_2 \neq 0$);

• $\overline{s\tilde{n}}_{(2)}, \odot, \odot; \binom{0}{2}SN, N^*$: Example \Rightarrow ((3.1) : $c = 1, e = 0, g = -2, l = 1, m = 2, n = 0$) (if $\theta = \theta_2 = 0$),

if $\tilde{M} \neq 0$ and one configuration

• $\overline{s\tilde{n}}_{(2)}, \odot, \odot; \binom{0}{3}N$: Example \Rightarrow ((3.1) : $c = 0, e = 1, g = 1/4, l = 3\sqrt{3}/4, m = 0, n = 1$) (if $\tilde{M} = 0$).

3.1.2 The case $E_1 = 0$

Then the double finite singular point, according to [8] is a cusp. As $\mu_0 \neq 0$ considering (3.2) we get the relation $cm + 2en = 0$.

The subcase $\eta < 0$ Then systems (3.1) possess one real and two complex infinite singular points and considering Lemmas 3.2 and 3.1 there could be only 3 distinct configurations at infinity. It remains to construct the corresponding examples:

• $\widehat{c\tilde{p}}_{(2)}, \odot, \odot; N^\infty, \odot, \odot$: Example \Rightarrow ((3.1) : $c = 2, e = 1, g = 5, l = 0, m = 1, n = -1$) (if $\theta < 0$);

• $\widehat{c\tilde{p}}_{(2)}, \odot, \odot; N^f, \odot, \odot$: Example \Rightarrow ((3.1) : $c = 2, e = 1, g = 3, l = 0, m = -1, n = 1$) (if $\theta > 0$);

• $\widehat{c\tilde{p}}_{(2)}, \odot, \odot; N^d, \odot, \odot$: Example \Rightarrow ((3.1) : $c = -2, e = 1, g = (3 + \sqrt{5})/2, l = 3, m = 1, n = 1$) (if $\theta = 0$).

The subcase $\eta > 0$ In this case systems (3.1) possess three real infinite singular points. Since for these systems the condition $\mu_0 > 0$ holds, taking into consideration Lemmas 3.2 and 3.1 we could have at infinity only 6 distinct configurations. The corresponding examples are:

• $\widehat{c\tilde{p}}_{(2)}, \odot, \odot; S, N^\infty, N^\infty$: Example \Rightarrow ((3.1) : $c = 2, e = 1, g = 12, l = 0, m = 5, n = -5$) (if $\theta < 0, \theta_1 < 0$);

• $\widehat{c\tilde{p}}_{(2)}, \odot, \odot; S, N^f, N^f$: Example \Rightarrow ((3.1) : $c = -2, e = 1, g = 2, l = 0, m = 1, n = 1$) (if $\theta < 0, \theta_1 > 0$);

• $\widehat{c\tilde{p}}_{(2)}, \odot, \odot; S, N^\infty, N^f$: Example \Rightarrow ((3.1) : $c = -1, e = 1, g = 2, l = 1, m = 2, n = 1$) (if $\theta > 0$);

• $\widehat{c\tilde{p}}_{(2)}, \odot, \odot; S, N^\infty, N^d$: Example \Rightarrow ((3.1) : $c = -2, e = 1, g = \frac{-17+37\sqrt{5}}{20}, l = \frac{-17}{10}, m = 1, n = 1$) (if $\theta = 0, \theta_1 < 0$);

• $\widehat{c\tilde{p}}_{(2)}, \odot, \odot; S, N^f, N^d$: Example \Rightarrow ((3.1) : $c = -\sqrt{3}, e = 1, g = 2, l = 0, m = 2/\sqrt{3}, n = 1$) (if $\theta = 0, \theta_1 > 0$);

• $\widehat{c\tilde{p}}_{(2)}, \odot, \odot; S, N^d, N^d$: Example \Rightarrow ((3.1) : $c = 1, e = 0, g = 0, l = -1, m = 0, n = 1$) (if $\theta = \theta_1 = 0$).

The subcase $\eta = 0$ In this case systems (3.1) possess at infinity either one double and one simple real singular points (if $\tilde{M} \neq 0$), or one triple real singularity (if $\tilde{M} = 0$). So by Lemmas 3.2 and 3.1 we could have at infinity exactly 4 distinct configurations. We have the following 3 configurations:

- $\widehat{c}p_{(2), \odot, \odot; \binom{0}{2}}SN, N^\infty$: Example \Rightarrow ((3.1) : $c = 1, e = -2, g = 4, l = 0, m = 4, n = 1$) (if $\theta < 0$);

- $\widehat{c}p_{(2), \odot, \odot; \binom{0}{2}}SN, N^f$: Example \Rightarrow ((3.1) : $c = 2, e = -1, g = 2, l = 0, m = 1, n = 1$) (if $\theta > 0$);

- $\widehat{c}p_{(2), \odot, \odot; \binom{0}{2}}SN, N^d$: Example \Rightarrow ((3.1) : $c = 1, e = -1/\sqrt{3}, g = 1, l = 0, m = 1, n = \sqrt{3}/2$) (if $\theta = 0$)

if $\tilde{M} \neq 0$ and one configuration

- $\widehat{c}p_{(2), \odot, \odot; \binom{0}{3}}N$: Example \Rightarrow ((3.1) : $c = 1, e = 0, g = 0, l = -2, m = 0, n = 1$) if $\tilde{M} = 0$.

3.2 Systems with one double and two simple real finite singularities

Assume that systems (2.1) possess one double and two simple real finite singularities. In this case according to [28] we shall consider the family of systems

$$\dot{x} = cx + cuy - cx^2 + 2hxy - cuy^2, \quad \dot{y} = ex + euy - ex^2 + 2mxy - euy^2, \quad (3.3)$$

with $u(cm - eh) \neq 0$, possessing the following three distinct singularities: $M_{1,2}(0,0)$, $M_3(1,0)$, $M_4(0,1)$. For these singularities we have the following values for the traces ρ_i , for the determinants Δ_i , for the discriminants τ_i and for the linearization matrices \mathcal{M}_3 and \mathcal{M}_4 :

$$\begin{aligned} \mathcal{M}_3 &= \begin{pmatrix} -c & 2h + cu \\ -e & 2m + eu \end{pmatrix}, \quad \mathcal{M}_4 = \begin{pmatrix} c + 2h & -cu \\ e + 2m & -eu \end{pmatrix}, \\ \rho_1 = \rho_2 = c + eu, \quad \Delta_1 = \Delta_2 = 0; \quad \rho_3 = -c + 2m + eu, \quad \Delta_3 = 2(eh - cm); \\ \rho_4 = c + 2h - eu, \quad \Delta_4 = -2(eh - cm)u; \quad \tau_i = \rho_i^2 - 4\Delta_i, \quad i = 1, 3, 4. \end{aligned} \quad (3.4)$$

Then for systems above we calculate

$$\begin{aligned} \mu_0 &= 4(eh - cm)^2 u = -\Delta_3 \Delta_4, \quad \tilde{K} = 2\Delta_3(x^2 - uy^2), \quad E_1 = -\Delta_3^2 \Delta_4^2 \rho_1 / 2, \\ \eta &= -4(\mathcal{N}_2^2 - \mathcal{N}_1 \mathcal{N}_3) / 3, \quad \tilde{M} = -8(\mathcal{N}_1 x^2 - 2\mathcal{N}_2 xy + \mathcal{N}_3 y^2), \\ \mathcal{T}_4 &= -\Delta_3 \Delta_4 \rho_1^2 \rho_3 \rho_4, \quad \mathcal{T}_3 = -\Delta_3 \Delta_4 \rho_1 [\rho_1(\rho_3 + \rho_4) + 2\rho_3 \rho_4], \\ \mathcal{T}_2 &= -\Delta_3 \Delta_4 [\rho_1^2 + 2\rho_1(\rho_3 + \rho_4) + \rho_3 \rho_4], \quad \mathcal{T}_1 = -\Delta_3 \Delta_4 (2\rho_1 + \rho_3 + \rho_4), \\ W_4 &= \Delta_3^2 \Delta_4^2 \rho_1^4 \tau_3 \tau_4, \quad W_3 = \Delta_3^2 \Delta_4^2 \rho_1^2 [\rho_1^2(\tau_3 + \tau_4) + 2\tau_3 \tau_4], \\ W_2 &= \Delta_3^2 \Delta_4^2 [\rho_1^4 + 2\rho_1^2(\tau_3 + \tau_4) + \tau_3 \tau_4], \quad W_1 = \Delta_3^2 \Delta_4^2 [2\rho_1^2 + \tau_3 + \tau_4], \end{aligned} \quad (3.5)$$

where

$$\begin{aligned} \mathcal{N}_1 &= c^2 - 6eh + 4cm + 4m^2 - 3e^2u, \quad \mathcal{N}_2 = ch + 2hm - 4ceu + emu, \\ \mathcal{N}_3 &= 4h^2 - 3c^2u + 4ehu - 6cmu + e^2u^2. \end{aligned}$$

Remark 3.4. In order to construct the examples or to prove nonexistence of some configurations, besides the family (3.3) we shall use here another normal form of quadratic systems, associated with singularities at infinity. So we will use the family of systems:

$$(S_3) \quad \dot{x} = cx + dy + gx^2 + hxy, \quad \dot{y} = ex + fy + (g - 1)xy + hy^2,$$

which have one double and one simple real distinct infinite singularities (i.e. $\eta = 0, \tilde{M} \neq 0$).

Lemma 3.5. *if for a system (3.3):*

- (i) *the condition $\tilde{M} = 0$ holds, then the conditions $\mu_0 < 0$ and $\rho_3\rho_4 = 0$ imply $\tau_3\tau_4 > 0$;*
- (ii) *the conditions $\rho_3\rho_4 = \mathcal{F}_1 = 0$, $\mu_0 < 0$ and $W_4 \neq 0$ are satisfied, then $\eta \neq 0$. Moreover if $\mathcal{F}_2 = 0$ then $\eta > 0$ and $\mathcal{F}_3\mathcal{F}_4 \neq 0$.*
- (iii) *the condition $\theta = 0$ holds then:*
 - (iii₁) *the conditions $\theta_1 \neq 0$ and $\theta_2 = 0$ imply $\tau_3\tau_4 \geq 0$ and we have $\tau_3\tau_4 = 0$ if and only if $\rho_3\rho_4 = 0$. In the case $\tau_3\tau_4 = 0$ the condition $\eta = 0$ is equivalent to $\mathcal{F}_1 = 0$;*
 - (iii₂) *the condition $\theta_1 = 0$ implies $\mu_0 = \eta$ and $\theta_2 = 0$ and furthermore a) if $E_1 = 0$ then the condition $\theta_2 = 0$ is equivalent to $\theta_1 = 0$. In addition $\theta_1 = \theta_2 = 0$ implies $\theta_3 \neq 0$; b) if $\theta_3 = 0$ then $\tau_3\tau_4 \geq 0$, $\theta_4 \neq 0$ and we have $\tau_3\tau_4 = 0$ if and only if $\rho_3\rho_4 = 0$.*
- (iv) *the conditions $\rho_3\rho_4 = \tau_3\tau_4 = \mathcal{F}_1 = 0$ and $\mu_0 < 0$ hold, then either $\mathcal{F}_2 \neq 0$ and $\eta < 0$, or $\mathcal{F}_2 = \mathcal{F}_3 = \eta = 0$.*
- (v) *the conditions $\rho_3\rho_4 = \theta = \theta_1 = 0$ hold, then $\mathcal{F}_1 \neq 0$. Moreover the condition $\tau_3\tau_4 = 0$ is equivalent to $\theta_3 = 0$.*

Proof. (i) Assume that for a system (3.3) the conditions $\tilde{M} = 0$, $\mu_0 < 0$ and $\rho_3\rho_4 = 0$ are fulfilled. We claim that in this case the condition $ce \neq 0$ holds. Indeed, considering (3.5) we detect, that in the case $ce = 0$ the conditions $\mathcal{N}_1 = \mathcal{N}_2 = \mathcal{N}_3 = 0$ yield either $c = m = 2h + eu = 0$ or $c + 2m = e = h = 0$. In the first case we obtain $\mu_0 = e^4u^3$, $\rho_3\rho_4 = -2e^2u^2$ and in the second one we get $\mu_0 = 16m^4u$, $\rho_3\rho_4 = -8m^2$. Therefore in both cases the condition $\mu_0 \neq 0$ implies $\rho_3\rho_4 \neq 0$. The contradiction obtained proves our claim.

Thus $ce \neq 0$ and the relations $\mathcal{N}_1 = \mathcal{N}_2 = \mathcal{N}_3 = 0$ are equivalent to $h = \frac{(4c-m)(c+2m)^2}{27ce}$, $u = \frac{(c+2m)^3}{27ce^2}$ and we calculate

$$\rho_3 = \frac{(c+2m)^3 - 27ce(c-2m)}{27ce}, \quad \rho_4 = \frac{(7c-4m)(c+2m)^2 + 27c^2e}{27ce}.$$

Since the condition $\rho_3\rho_4 = 0$ holds, without loss of generality we may assume $\rho_4 = 0$, i.e. $e = \frac{(4m-7c)(c+2m)^2}{27c^2} \neq 0$ and then we calculate

$$\tau_3\tau_4 = \frac{2^{10}c(5c-8m)(c-m)^6}{27(7c-4m)^4}, \quad \mu_0 = \frac{64c(c-m)^6}{27(7c-4m)^2(c+2m)}.$$

So the condition $\mu_0 < 0$ implies $c(c+2m) < 0$ and then $cm < 0$. Therefore $c(5c-8m) > 0$ which implies $\tau_3\tau_4 > 0$ and this completes the proof of the statement (i) of the lemma.

(ii) Assume that for a system (3.3) the conditions $\rho_3\rho_4 = 0$ and $\mathcal{F}_1 = 0$ hold. Without loss of generality we may assume $\rho_3 = 0$ (i.e. $m = (c - eu)/2$) and then we calculate

$$\mathcal{F}_1 = u(ceu - c^2 + 2eh)(2c^2 + 3ce + 2eh + 2ceu + e^2u), \quad \mu_0 = u(ceu - c^2 + 2eh)^2. \quad (3.6)$$

So due to $\mu_0 \neq 0$ the condition $\mathcal{F}_1 = 0$ yields $2c^2 + e(3c + 2h + 2cu + eu) = 0$ and we observe that $e \neq 0$, otherwise we get $c = 0$ and this implies $\mu_0 = 0$. Therefore we obtain $h = -(2c^2 + 3ce + 2ceu + e^2u)/(2e)$ and we calculate

$$\eta = 4c(c+e)\Psi_1(c, e, u)/e^2, \quad \mu_0 = u(c+e)^2(3c+eu)^2, \quad W_4 = c(c+eu)^4\Psi_2(c, e, u)/e^2, \\ \mathcal{F}_2 = -c(c+e)^4u^2(c+eu)^4(3c+eu)^2(6c+eu)/e^2,$$

where $\Psi_2(c, e, u)$ is a polynomial and

$$\Psi_1(c, e, u) = 12c^4 + 4c^3e(9+7u) + 3c^2e^2(9+6u+7u^2) + 3ce^3u^2(3+2u) + u^4e^4. \quad (3.7)$$

Suppose that the conditions $\mu_0 < 0$ and $W_4 \neq 0$ are satisfied. Then the condition $\eta = 0$ is equivalent to $\Psi_1(c, e, u) = 0$. According to Lemma 2.1 for this quartic equation with respect to c we calculate:

$$\begin{aligned}\widehat{D} &= 19683e^{12}u^5(u-2)^3(4u-9)(1+2u+2u^2)/16, \\ \widehat{R} &= e^2(27+90u+7u^2), \quad \widehat{S} = -48e^4u(8u^3-477u^2-1998u-972)\end{aligned}$$

We observe that $\mu_0 < 0$ and $\Psi_1(c, e, u) = 0$ imply $u < 0$ and $e \neq 0$. Then $\widehat{D} < 0$ and checking the roots of the polynomials $\widehat{R}|_{e=1}$ and $\widehat{S}|_{e=1}$ it is easy to determine that the possibility $\widehat{R} > 0$ and $\widehat{S} > 0$ (simultaneously) cannot be realized.

Thus by Lemma 2.1 the polynomial $\Psi_1(c, e, u)$ does not have real roots, i.e. $\eta \neq 0$.

Next, if we impose the condition $\mathcal{F}_2 = 0$ (i.e. $c = -eu/6$) to be fulfilled, then we obtain:

$$\begin{aligned}\eta &= e^4(u-6)u^3(81-126u+50u^2)/972, \quad \mu_0 = e^4(u-6)^2u^3/144, \\ \mathcal{F}_3\mathcal{F}_4 &= 5^7e^{20}(u-6)^8u^{19}/(2^{17}3^{19}),\end{aligned}$$

and clearly the condition $\mu_0 < 0$ implies $\eta > 0$ and $\mathcal{F}_3\mathcal{F}_4 \neq 0$. This completes the proof of the statement (ii).

(iii) Assume now that for systems (3.3) the condition $\theta = 0$ is satisfied. For these systems we have

$$\theta = 64(eh - cm)[(h + eu)^2 - (c + m)^2u], \quad \mu_0 = 4u(eh - cm)^2$$

and as $\mu_0 \neq 0$ the condition $\theta = 0$ implies $(h + eu)^2 - (c + m)^2u = 0$.

(iii₁) Assume first $\theta_1 \neq 0$. We observe that in this case the condition $c + m \neq 0$ must hold, otherwise we get $c + m = h + eu = 0$ and this implies $\theta_1 = 0$. So $c + m \neq 0$ and setting a new parameter $v = h + eu$ (then $h = v - eu$) the condition $\theta = 0$ gives $u = v^2/(c + m)^2$. Then we calculate

$$\begin{aligned}\theta = 0, \quad \theta_1 &= \frac{256v^2(cm + m^2 - ev)^3}{(c + m)^4}, \quad \mu_0 = \frac{4v^2(c^2 + cm - ev)^2(cm + m^2 - ev)^2}{(c + m)^6}, \\ \theta_2 &= -\frac{v(c + m + v)(c^2 + cm - ev)(cm + m^2 - ev)}{(c + m)^3}\end{aligned}\tag{3.8}$$

and due to $\mu_0 \neq 0$ the condition $\theta_2 = 0$ yields $c + m + v = 0$ (i.e. $v = -c - m$) and this gives

$$\tau_3\tau_4 = \rho_3^2\rho_4^2 \geq 0, \quad \mu_0 = 4(c + e)^2(e + m)^2$$

and obviously the condition $\tau_3\tau_4 = 0$ is equivalent to $\rho_3\rho_4 = 0$. Moreover if we suppose that $\rho_3\rho_4 = 0$, then we may assume $\rho_3 = 0$ (i.e. $c = e + 2m$) and we calculate

$$\mathcal{F}_1 = -16(e + m)^3(e + 2m), \quad \eta = 32(e + m)^3(e + 2m)$$

and evidently the condition $\mathcal{F}_1 = 0$ is equivalent to $\eta = 0$.

(iii₂) Suppose now $\theta_1 = 0$. Then $c + m = 0$ otherwise we obtain (3.8) and therefore the condition $\mu_0 \neq 0$ implies $\theta_1 \neq 0$. So assuming $m = -c$ and $h = -eu$ we obtain

$$\begin{aligned}\theta = \theta_1 = \theta_2 = 0, \quad E_1 &= -8u^2(c + eu)(c^2 - e^2u)^4, \\ \mu_0 &= 4u(c^2 - e^2u)^2 = \eta, \quad \theta_3 = 2u(1 - u)(c^2 - e^2u)^3.\end{aligned}\tag{3.9}$$

a) Assume $E_1 = 0$. Due to $\mu_0 \neq 0$ this condition is equivalent to $c + eu = 0$, i.e. $c = -eu$ and then we get $\theta_3 = 2e^6(u - 1)^4u^4 \neq 0$ due to $\mu_0 = 4e^4(u - 1)^2u^3 \neq 0$.

b) Assume now $\theta_3 = 0$. Since $\mu_0 \neq 0$ we get $u = 1$ and this gives

$$\tau_3\tau_4 = \rho_3^2\rho_4^2, \quad \theta_4 = -4(c-e)^4(c+e), \quad \mu_0 = 4(c-e)^2(c+e)^2.$$

Clearly $\theta_4 \neq 0$ due to $\mu_0 \neq 0$ and the condition $\tau_3\tau_4 = 0$ is equivalent to $\rho_3\rho_4 = 0$. This completes the proof of the statement (iii) of the lemma.

(iv) Assume that for a system (3.3) the conditions $\rho_3\rho_4 = 0$ and $\mathcal{F}_1 = 0$ hold. As it was shown in the proof of the statement (ii) supposing $\rho_3 = \mathcal{F}_1 = 0$ we arrive at the following relations:

$$m = (c - eu)/2, \quad h = -(2c^2 + 3ce + 2ceu + e^2u)/(2e)$$

where $e \neq 0$ due to $\mu_0 \neq 0$. Since we choose $\rho_3 = 0$ then the condition $\tau_3\tau_4 = 0$ gives $\tau_4 = 0$ (since the singular point $M_3(1, 0)$ is elemental). We calculate

$$\tau_4 = \frac{4c(c+e)}{e^2} [(c+eu)^2 + e(c-eu)] \equiv \frac{4c(c+e)}{e^2} \zeta(c, e, u), \quad \mu_0 = (c+e)^2u(3c+eu)^2$$

and as $\mu_0 \neq 0$, the condition $\tau_4 = 0$ yields $c\zeta = 0$.

if $c = 0$ then calculations yield $\mathcal{F}_2 = \mathcal{F}_3 = \eta = 0$, i.e. in this case the statement (iv) is valid.

Assume now $c \neq 0$. Then $\zeta(c, e, u) = 0$ and as $\text{Discrim}[\zeta, c] = e^2(1 + 8u)$, to factorize this polynomial we set a new variable v as follows: $1 + 8u = v^2 \geq 0$, i.e. $u = (v^2 - 1)/8$. Then we obtain

$$\zeta = (8c + 3e - 4ev + ev^2)(8c + 3e + 4ev + ev^2)/64 = 0$$

and we may assume $(8c + 3e - 4ev + ev^2) = 0$ as the second possibility can be obtained from the first one by substituting v with $-v$.

Thus we obtain $c = e(3 - v)(v - 1)/8$ and we calculate

$$\begin{aligned} \mu_0 &= 2^{-13}e^4(v-5)^4(v^2-1)^3, & \mathcal{F}_2 &= 2^{-32}e^{10}(v-5)^6(3-v)(v-1)^{10}(1+v)^6(5v-19), \\ \eta &= 2^{-13}e^4(v-5)^2(3-v)(v-1)^2(v^2-1)(205+67v-65v^2+9v^3). \end{aligned}$$

We observe that the equation $205 + 67v - 65v^2 + 9v^3 = 0$ possesses a single real root $v_0 < 1.25$. Therefore obviously the condition $\mu_0 < 0$ (i.e. $|v| < 1$) implies $\eta < 0$ and $\mathcal{F}_2 \neq 0$. This completes the proof of the statement (iv) of Lemma 3.5.

(v) Assume that for a system (3.3) the condition $\theta = \theta_1 = 0$ holds. As it was shown in the proof of the statement (iii) in this case the conditions $m = -c$ and $h = -eu$ are fulfilled and we obtain $\rho_3\rho_4 = (eu - 3c)(c - 3eu) = 0$. As it was mentioned earlier we may assume $\rho_3 = 0$ (i.e. $c = eu/3$) and we calculate

$$\begin{aligned} \mathcal{F}_1 &= 16e^4u^4(u-9)/81, & \theta_3 &= 2e^6(u-9)^3(u-1)u^4/729, \\ \mu_0 &= 4e^4u^3(u-9)^2/81, & \tau_3\tau_4 &= -64e^4(u-9)(u-1)u^3/81. \end{aligned}$$

Clearly the condition $\mu_0 \neq 0$ implies $\mathcal{F}_1 \neq 0$ and the condition $\tau_3\tau_4 = 0$ is equivalent to $\theta_3 = 0$. This completes the proof of the statement (v) and also the proof of Lemma 3.5. \square

Lemma 3.6. *A system (3.3) possesses a finite star node if and only if the condition $U_3 = 0$ holds and in this case the star node is unique. Moreover, for a system (3.3) the condition $U_3 = 0$ implies $\eta = \theta_2 = 0$ and $E_1\tilde{M} \neq 0$.*

Proof. Assume that a system (3.3) possess a finite star node. Then without loss of generality we may consider that such a point is $M_2(1,0)$ and considering (3.4) we obtain $c = 0$, $m = -c/2$ and $h = -cu/2$. Herein we get $U_3 = 0$.

Conversely, assume that $U_3 = 0$. Evaluating the invariant polynomial U_3 for systems (3.3) we have

$$\text{Coefficient}[U_3, x^5] = eU', \quad \text{Coefficient}[U_3, y^5] = cuU'',$$

where U' and U'' are some polynomials in the parameters of these systems. As $u \neq 0$ (due to $\mu_0 \neq 0$) we shall consider three cases: (i) $e = 0$; (ii) $c = 0$ and (iii) $ce \neq 0$.

(i) *The case $e = 0$.* Then we calculate

$$\mu_0 = 4c^2m^2u \neq 0, \quad \text{Coefficient}[U_3, x^4y] = -12c^2m^2(c + 2m) = 0$$

and this implies $m = -c/2$. Herein we obtain

$$U_3 = 3c^2(2h + cu)y^2(c^2x^3 + c^2ux^2y + 2c^2uxy^2 + 6chuxy^2 + 2chuy^3 + 4h^2uy^3 - c^2u^2y^3)$$

and $\mu_0 = c^4u \neq 0$. Then obviously we obtain that the condition $U_3 = 0$ is equivalent to $2h + cu = 0$, i.e. $h = -cu/2$ and this implies that the singular point $M_2(1,0)$ is a star node.

(ii) *The case $c = 0$.* In this case calculations yield

$$\mu_0 = 4e^2h^2u \neq 0, \quad \text{Coefficient}[U_3, xy^4] = 12e^2h^2u^2(2h + eu)$$

and hence the condition $U_3 = 0$ implies $h = -eu/2$. Herein we get

$$U_3 = -3e^2(e + 2m)ux^2[(4m^2 - e^2u + 2emu)x^3 + 2eu(3m + eu)x^2y + e^2u^2xy^2 + e^2u^3y^3]$$

and $\mu_0 = e^4u^3 \neq 0$. Clearly the condition $U_3 = 0$ is equivalent to $e + 2m = 0$, i.e. $m = -e/2$ and this implies that the singular point $M_4(0,1)$ is a star node.

(iii) *The case $ce \neq 0$.* Considering the matrices (3.4) we conclude that in this case we could not have a star node. So in what follows we shall prove that in the case $ce \neq 0$ the invariant polynomial U_3 could not vanish. We calculate

$$\begin{aligned} \text{Coefficient}[U_3, y^5] &= 12cu \left[e^2h^2u^2 - 2cehu(c + 2h + cu + mu) \right. \\ &\quad \left. + c(c^3u(1 + u) + 2c^2u(h + m + mu) \right. \\ &\quad \left. + c(4hmu - h^2 - h^2u + m^2u^2 - 2h^3)) \right] \\ &\equiv 12cu\Phi_1(c, e, h, m, u) \end{aligned}$$

We observe that the polynomial Φ_1 is a quadratic polynomial in e and therefore the condition

$$\text{Discrim}[\Phi_1, e] = 4ch^2(c + h)^2u^2(c + 2h + cu) \geq 0$$

must hold. Since $cu \neq 0$ we conclude that the following conditions have to be fulfilled: either $h = 0$ or $h = -c$ or $h(h + c) \neq 0$ and $c(c + 2h + cu) = v^2 \geq 0$.

1) *The subcase $h = 0$.* Then we have

$$\Phi_1 = c^2u[(c + m)^2u + c(c + 2m)] = 0$$

and we observe that due to $cu \neq 0$ the condition $c + m \neq 0$ holds. Therefore we get $u = -c(c + 2m)/(c + m)^2$ and then we calculate

$$\begin{aligned} \text{Coefficient}[U_3, xy^4] &= 24c^5m(c + 2m)^2(c^2 + 4cm + 2em + 3m^2)/(c + m)^5, \\ \mu_0 &= -4c^3m^2(c + 2m)/(c + m)^2. \end{aligned}$$

So due to $\mu_0 \neq 0$ the condition $U_3 = 0$ gives $e = -(c+m)(c+3m)/(2m)$ and calculations yield:

$$\begin{aligned} \text{Coefficient}[U_3, x^2y^3] &= \frac{6c^4(c+2m)^2(3c^2+6cm-5m^2)}{(c+m)^3} = 0, \\ \text{Coefficient}[U_3, x^3y^2] &= \frac{3c^3(c+2m)(c+3m)(7c^4+35c^3m+43c^2m^2+cm^3+2m^4)}{m(c+m)^3} = 0. \end{aligned}$$

Since $\mu_0 \neq 0$ the equations above (which are forms in two variables) have not common solutions, i.e. U_3 could not vanish.

2) The subcase $h = -c \neq 0$. Then we obtain

$$\Phi_1 = c^2(-c + cu + eu + mu)^2 = 0$$

and due to $cu \neq 0$ we get $e = (c - cu - mu)/u$. Herein we calculate

$$\begin{aligned} \text{Coefficient}[U_3, x^2y^3] &= 48c^3(u-1)^2[c^2(1-u) + u^2(c+m)^2]/u \\ &\equiv \frac{48c^3(u-1)^2}{u} \Phi_2(c, m, u) = 0, \quad \mu_0 = 4c^4(u-1)^2/u \end{aligned}$$

and due to $\mu_0 \neq 0$ we get $\Phi_2 = 0$. We observe that the polynomial Φ_2 is a quadratic polynomial in c and therefore the condition $\text{Discrim}[\Phi_2, c] = 4m^2(u-1)u^2 \geq 0$ must hold. Since $mu(u-1) \neq 0$ (if $m = 0$ then $\Phi_2 = c^2(1-u+u^2) \neq 0$) we conclude that the condition $u-1 = w^2 > 0$ must hold. Hence $u = w^2 + 1$ and we obtain $\Phi_2 = (c+m-cw+cw^2+mw^2)(c+m+cw+cw^2+mw^2) = 0$. This leads to the relation $m = -\frac{c(1 \pm w + w^2)}{1+w^2}$ and we calculate

$$U_3 = \frac{24c^5(1 \pm w)w^6x^3(\mp wx + 2y + 2w^2y)^2}{(1+w^2)^4}, \quad \mu_0 = \frac{4c^4w^4}{1+w^2}.$$

Thus considering the change above we obtain $e = (c - cu - mu)/u = c(1 \pm w)/(1+w^2) \neq 0$ and we again get $U_3 \neq 0$.

3) The subcase $c(c+2h+cu) = v^2 \geq 0$ and $h(c+h) \neq 0$. Since $c \neq 0$ we obtain $h = -(c^2 + c^2u - v^2)/(2c) \neq 0$ and then we calculate

$$\begin{aligned} \Phi_1 &= \left[eu(c^2 + c^2u - v^2) + 2c(cmu + v^2) + v(c^2 - c^2u + v^2) \right] \\ &\quad \times \left[eu(c^2 + c^2u - v^2) + 2c(cmu + v^2) - v(c^2 - c^2u + v^2) \right] / (4c^2) = 0. \end{aligned}$$

Therefore due to $h \neq 0$ (i.e. $c^2 + c^2u - v^2 \neq 0$) we obtain

$$e = -2c^2mu - c^2v + c^2uv - 2cv^2 - v^3 / (u(c^2 + c^2u - v^2)).$$

Herein we calculate

$$\begin{aligned} \text{Coefficient}[U_3, xy^4] &= -\frac{3v(c^2u - c^2 - v^2)(c^2u - c^2 - 2cv - v^2)}{c^3(c^2 + c^2u - v^2)} \Phi_3(c, m, u, v), \\ \mu_0 &= \frac{v^2(c^2u - c^2 - 2cv - v^2)^2}{c^2u}, \quad c+h = \frac{c^2 - c^2u + v^2}{2c} \neq 0, \end{aligned}$$

where $\Phi_3 = c^4u^2(c+v) - (c+v)^3(c^2+2cv-v^2) - 2c^2uv(2c^2+4cm+cv+v^2)$. As $\mu_0 \neq 0$ and $(c+h) \neq 0$ we conclude that the condition $U_3 = 0$ implies $\Phi_3 = 0$. Then we obtain

$$m = \frac{c^4u^2(c+v) - (c+v)^3(c^2+2cv-v^2) - 2c^2uv(2c^2+cv+v^2)}{8c^3uv}$$

and calculations yield

$$\begin{aligned} \text{Coefficient}[U_3, x^2y^3] &= -\frac{3(c+v)(c^2-c^2u+v^2)(c^2-c^2u+2cv+v^2)}{8c^5u}\Phi_4(c, u, v), \\ \mu_0 &= \frac{v^2(c^2-c^2u+2cv+v^2)^2}{c^2u}, \quad e = \frac{(c+v)(c^2-c^2u+4cv+v^2)}{4cuv} \neq 0, \end{aligned}$$

where

$$\Phi_4 = 3c^4u^2(c-v) - 2c^2u(3c^3+3c^2v-5cv^2-3v^3) + (c+v)(3c^4+6c^3v-16c^2v^2-10cv^3-3v^4).$$

As $\mu_0 \neq 0$ and $e(c+h) \neq 0$ we conclude that the condition $U_3 = 0$ implies $\Phi_4 = 0$.

On the other hand we have

$$\begin{aligned} \text{Coefficient}[U_3, x^3y^2] &= -\frac{3(c+v)(c^2u-c^2-2cv-v^2)}{32c^7u^2v}\Phi_5(c, u, v), \\ \text{Coefficient}[U_3, x^4y] &= -\frac{3(c+v)(c^2u-c^2-2cv-v^2)}{256c^9u^3v^2}\Phi_6(c, u, v), \end{aligned}$$

where

$$\begin{aligned} \Phi_5 &= 7c^{10}(u-1)^4 + 2c^9(-27+u)(u-1)^3v - c^8(u-1)^2(-119+u(2+5u))v^2 \\ &\quad + 4c^7(u-1)^2(-6+5u)v^3 + 2c^6(u-1)(93+u(-23+10u))v^4 + 4c^5(5+(13-18u)u)v^5 \\ &\quad + 10c^4(19+(8-3u)u)v^6 + 4c^3(18+19u)v^7 + c^2(-29+20u)v^8 - 26cv^9 - 5v^{10}, \\ \Phi_6 &= 11c^{13}(u-1)^5 + c^{12}(u-1)^4(-139+17u)v + c^{11}(u-1)^3(678+(-167+u)u)v^2 \\ &\quad - c^{10}(u-1)^2(1478+5u(-147+u(4+u)))v^3 + c^9(u-1)^2(-917+u(-140+33u))v^4 \\ &\quad + c^8(u-1)(-1899+u(1451+u(-89+25u)))v^5 \\ &\quad - 2c^7(u-1)(1950+u(-229+71u))v^6 \\ &\quad + 2c^6(1166+u(-617+(116-25u)u))v^7 + c^5(u-1)(261+218u)v^8 \\ &\quad + c^4(-869+u(-167+50u))v^9 - c^3(278+147u)v^{10} + c^2(42-25u)v^{11} + 37cv^{12} + 5v^{13}. \end{aligned}$$

We calculate

$$\text{Resultant}[\Phi_4, \Phi_5, u] = 3 \cdot 2^{17}c^{24}v^{10}(c+v)\mathcal{A}, \quad \text{Resultant}[\Phi_4, \Phi_6, u] = -2^{20} \cdot 9c^{30}v^{13}(c+v)^2\mathcal{B},$$

where

$$\begin{aligned} \mathcal{A} &= 15c^5 + 18c^4v - 15c^3v^2 - 10c^2v^3 + 4cv^4 + 2v^5, \\ \mathcal{B} &= 38c^6 + 148c^5v + 125c^4v^2 - 108c^3v^3 - 8c^2v^4 + 8cv^5 + v^6. \end{aligned}$$

So to have $U_3 = 0$ (i.e. $\Phi_4 = \Phi_5 = \Phi_6 = 0$) the polynomials \mathcal{A} and \mathcal{B} must have a common solution (factor). However,

$$\text{Resultant}[\mathcal{A}, \mathcal{B}, c] = 73805864677632v^{30} \neq 0$$

and this proves that U_3 could not vanish. As all the cases are examined we conclude that the condition $U_3 = 0$ is necessary and sufficient for the existence of a star node of systems (3.3). It remains to observe that in the case $U_3 = 0$ the uniqueness of the star node follows directly from (3.4), because for the matrices \mathcal{M}_3 and \mathcal{M}_4 corresponding to the elemental singularities we could not have simultaneously $e = cu = 0$ due to $\mu_0 \neq 0$.

Suppose now that the condition $U_3 = 0$ is fulfilled for a system (3.3). We may assume $M_3(1,0)$ to be a star node, i.e. the conditions $e = 0, h = -cu/2$ and $m = -c/2$ hold. Then we calculate

$$\mu_0 = c^4u, \quad \eta = \theta_2 = 0, \quad E_1 = -c^9u^2/2, \quad \tilde{M} = -8c^2u^2y^2$$

and clearly the condition $\mu_0 \neq 0$ gives $E_1\tilde{M} \neq 0$. This completes the proof of the lemma. \square

In what follows we determine the geometric configurations of systems (3.3).

3.2.1 The case $\mu_0 < 0$

Then $u < 0$ and hence $\text{sign}(\tilde{K}) = \text{sign}(\Delta_3) = \text{sign}(\Delta_4)$.

The subcase $\tilde{K} < 0$ Then the elemental singular points are both saddles and by [8] the type of the double singular point is governed by the invariant polynomial E_1 . On the other hand at infinity we must have three nodes as the sum of the indices of the finite singularities equals -2.

The possibility $E_1 \neq 0$ In this case $\rho_1 \neq 0$ and besides the two saddles we have a semi-elemental saddle-node.

1) *The case $\mathcal{T}_4 \neq 0$.* Then $\rho_3\rho_4 \neq 0$ and both saddles are strong. So we arrive at the configuration

- $s, s, \overline{s\bar{n}}_{(2)}; N^f, N^f, N^f$: Example $\Rightarrow ((3.3) : c = 1, e = 0, h = 0, m = 1, u = -1)$

2) *The case $\mathcal{T}_4 = 0$.* By (3.5) we get $\rho_3\rho_4 = 0$ and we consider two subcases: $\mathcal{T}_3 \neq 0$ and $\mathcal{T}_3 = 0$.

a) *The subcase $\mathcal{T}_3 \neq 0$.* Then by [28] only one saddle is weak.

a₁) *The possibility $\mathcal{F}_1 \neq 0$.* In this case according to [28] the weak saddle is of order one and we get the configuration

- $s, s^{(1)}, \overline{s\bar{n}}_{(2)}; N^f, N^f, N^f$: Example $\Rightarrow ((3.3) : c = 1, e = 3, h = 0, m = 2, u = -1)$.

a₂) *The possibility $\mathcal{F}_1 = 0$.* Then by [28] the weak saddle has the order ≥ 2 . We claim that in this case the condition $\mathcal{F}_2 \neq 0$ must be satisfied. Indeed, as the conditions $\mathcal{T}_4 = 0$ and $E_1 \neq 0$ imply $\rho_3\rho_4 = 0$ we may assume that the singular point M_2 is weak (i.e. $\rho_3 = 0$) and this gives to the relation: $m = (c - eu)/2$. This leads to the values of \mathcal{F}_1 and μ_0 given in (3.6).

We observe that the conditions $\mathcal{F}_1 = 0$ and $\mu_0 \neq 0$ imply $e \neq 0$, otherwise we get $\mathcal{F}_1 = -2c^4u = 0$ which contradicts $\mu_0 = c^4u \neq 0$. So $e \neq 0$ and the condition $\mathcal{F}_1 = 0$ is equivalent to $h = -(2c^2 + 3ce + 2ceu + e^2u)/(2e)$. Herein we calculate

$$\mathcal{F}_2 = -c(c+e)^4u^2(c+eu)^4(3c+eu)^2(6c+eu)/e^2, \quad E_1 = -(c+e)^4u^2(c+eu)(3c+eu)^4/2$$

and clearly due to $E_1 \neq 0$ the condition $\mathcal{F}_2 = 0$ implies $c(6c+eu) = 0$. However we get $\mu_0 = e^4u^3, \tilde{K} = 2e^2u(x^2 - uy^2)$ if $c = 0$ and

$$\mu_0 = e^4(u-6)^2u^3/144, \quad \tilde{K} = e^2u(u-6)(x^2 - uy^2)/6 \quad \text{if } c = -eu/6$$

and in both cases the condition $\mu_0 < 0$ implies $\tilde{K} > 0$. This contradiction proves our claim.

Thus $\mathcal{F}_2 \neq 0$ and by [28] the weak saddle has order 2. This leads to the configuration

- $s, s^{(2)}, \overline{s\bar{n}}_{(2)}; N^f, N^f, N^f$: Example $\Rightarrow ((3.3) : c = 1, e = 1/3, h = -10/3, m = 2/3, u = -1)$.

b) The subcase $\mathcal{T}_3 = 0$. Considering (3.5) and the condition $E_1 \neq 0$ (i.e. $\rho_1 \neq 0$) we obtain $\rho_3 = \rho_4 = 0$ and $\mathcal{T}_2 \neq 0$. Then by [28] we have two weak saddles. We claim that in this case the condition $\mathcal{F}_1 \neq 0$ must hold. Indeed, the conditions $\rho_3 = \rho_4 = 0$ yield $m = (c - eu)/2$ and $h = (eu - c)/2$ and then we calculate:

$$\mathcal{F}_1 = 2(c + e)^2 u(eu - c)(c + eu), \quad E_1 = -(c + e)^4 u^2 (c - eu)^4 (c + eu)/2.$$

It is evident that the condition $E_1 \neq 0$ implies $\mathcal{F}_1 \neq 0$ and our claim is proved.

Thus by [28] both weak saddles are of the first order and we obtain the configuration

- $s^{(1)}, s^{(1)}, \bar{s}\bar{n}_{(2)}; N^f, N^f, N^f$: Example \Rightarrow ((3.3) : $c = -3, e = 1, h = 1, m = -1, u = -1$).

The possibility $E_1 = 0$. In this case $\rho_1 = 0$ and besides the two saddles we have a cusp. Then $c = -eu$ and by (3.5) we obtain

$$\mathcal{T}_4 = \mathcal{T}_3 = 0, \quad \mathcal{T}_2 = -\Delta_3 \Delta_4 \rho_3 \rho_4, \quad \mathcal{T}_1 = -\Delta_3 \Delta_4 (\rho_3 + \rho_4).$$

1) The case $\mathcal{T}_2 \neq 0$. Then $\rho_3 \rho_4 \neq 0$ and both saddles are strong. So we arrive at the configuration

- $s, s, \hat{c}\hat{p}_{(2)}; N^f, N^f, N^f$: Example \Rightarrow ((3.3) : $c = 1, e = 1, h = 1, m = 2, u = -1$)

2) The case $\mathcal{T}_2 = 0$. This implies $\rho_3 \rho_4 = 0$ and we consider two subcases: $\mathcal{T}_1 \neq 0$ and $\mathcal{T}_1 = 0$

a) The subcase $\mathcal{T}_1 \neq 0$. Then only one saddle is weak. We claim that in this case we could have a weak saddle only of order one, i.e. that the condition $\mathcal{F}_1 \neq 0$ holds.

Indeed, as the condition $\mathcal{T}_2 = 0$ implies $\rho_3 \rho_4 = 0$, we may assume that the singular point M_2 is weak and then the relations $\rho_1 = \rho_3 = 0$ give $c = -eu = m$. Then we calculate

$$\mathcal{F}_1 = 4e^2 u(h - eu)(h - eu^2), \quad \mathcal{T}_1 = 8e^2 u(h - eu)(h - eu^2)^2$$

and obviously the condition $\mathcal{T}_1 \neq 0$ implies $\mathcal{F}_1 \neq 0$ and this proves our claim.

So the weak saddle is of order one and we get the configuration

- $s, s^{(1)}, \hat{c}\hat{p}_{(2)}; N^f, N^f, N^f$: Example \Rightarrow ((3.3) : $c = 1, e = 1, h = -2, m = 1, u = -1$).

b) The subcase $\mathcal{T}_1 = 0$. We observe that in this case all the traces vanish (this implies $\sigma = 0$) and we arrive at the Hamiltonian systems. So we obtain the configuration

- $s, s, \hat{c}\hat{p}_{(2)}; N^f, N^f, N^f$: Example \Rightarrow ((3.3) : $c = -1, e = -1, h = 1, m = -1, u = -1$).

The subcase $\tilde{K} > 0$ Then according to [8] the elemental singular points are both anti-saddles and the type of the double singular point is governed by the invariant polynomial E_1 .

The possibility $E_1 \neq 0$ In this case $\rho_1 \neq 0$ and besides the two anti-saddles we have a semi-elemental saddle-node.

1) The case $W_4 < 0$. According to [8] we have a node and a focus. Moreover the node is generic, whereas the type of the focus depends on the invariant polynomial \mathcal{T}_4 .

a) The subcase $\mathcal{T}_4 \neq 0$. Then the focus is strong. Since the total index of the finite singularities equals +2 we deduce that at infinity we must have singular points of a total index -1. So considering Lemma 3.1 we arrive at the following 4 configurations

- $n, f, \bar{s}\bar{n}_{(2)}; S, \odot, \odot$: Example \Rightarrow ((3.3) : $c = 1, e = 47/20, h = 1, m = 1/10, u = -1$) (if $\eta < 0$)

- $n, f, \overline{sn}_{(2)}; S, S, N^\infty$: Example \Rightarrow ((3.3) : $c = 1, e = 5, h = 1, m = 1, u = -1$) (if $\eta > 0$);
- $n, f, \overline{sn}_{(2)}; \binom{0}{2} SN, S$: Example \Rightarrow ((3.3) : $c = -2, e = -1, h = 1, m = 1, u = -1$) (if $\eta = 0, \tilde{M} \neq 0$);
- $n, f, \overline{sn}_{(2)}; \binom{0}{3} S$: Example \Rightarrow ((3.3) : $c = 1, e = 1, h = 5/27, m = -1, u = -1/27$) (if $\eta = 0, \tilde{M} = 0$).

b) The subcase $\mathcal{T}_4 = 0$. Considering (3.5) and the condition $E_1 \neq 0$ we get $\rho_3\rho_4 = 0$, i.e. the focus is weak. Then without loss of generality we may assume that the singularity $M_3(1,0)$ is a weak focus, i.e. $m = (c - eu)/2$. In this case we obtain

$$\mathcal{T}_4 = 0, \quad \mathcal{F}_1 = u(ceu - c^2 + 2eh)(2c^2 + 3ce + 2eh + 2ceu + e^2u), \quad \mu_0 = u(-c^2 + 2eh + ceu)^2.$$

By Lemma 3.5 in this case the condition $\tilde{M} \neq 0$ holds and we consider two possibilities: $\mathcal{F}_1 \neq 0$ and $\mathcal{F}_1 = 0$.

b₁) The possibility $\mathcal{F}_1 \neq 0$. By [28] the weak focus has order one and considering Lemma 3.1 we arrive at the following 3 configurations

- $n, f^{(1)}, \overline{sn}_{(2)}; S, \odot, \odot$: Example \Rightarrow ((3.3) : $c = 1, e = 2, h = 2, m = 3/2, u = -1$) (if $\eta < 0$);
- $n, f^{(1)}, \overline{sn}_{(2)}; S, S, N^\infty$: Example \Rightarrow ((3.3) : $c = 1, e = 2, h = 1, m = 3/2, u = -1$) (if $\eta > 0$);
- $n, f^{(1)}, \overline{sn}_{(2)}; \binom{0}{2} SN, S$: Example \Rightarrow ((3.3) : $c = 0, e = 8/5, h = 1, m = 4/5, u = -1$) (if $\eta = 0$).

b₂) The possibility $\mathcal{F}_1 = 0$. In this case we have a weak focus of order at least two. According to Lemma 3.5 in this case the condition $\eta \neq 0$ is verified.

α) The case $\mathcal{F}_2 \neq 0$. By [28] the weak focus has order one and considering Lemma 3.1 and the condition $\eta \neq 0$ we arrive at the following 2 configurations:

- $n, f^{(2)}, \overline{sn}_{(2)}; S, \odot, \odot$: Example \Rightarrow ((3.3) : $c = 1, e = -2, h = -1, m = 7/16, u = -1/16$) (if $\eta < 0$);
- $n, f^{(2)}, \overline{sn}_{(2)}; S, S, N^\infty$: Example \Rightarrow ((3.3) : $c = 1, e = 4, h = 5/4, m = 5/2, u = -1$) (if $\eta > 0$).

β) The possibility $\mathcal{F}_2 = 0$. Since by Lemma 3.5 we have $\mathcal{F}_3\mathcal{F}_4 \neq 0$ and $\eta > 0$, according to [28] the weak focus has order three and we get one configuration

- $n, f^{(3)}, \overline{sn}_{(2)}; S, S, N^\infty$: Example \Rightarrow ((3.3) : $c = 1/6, e = 1, h = 7/18, m = 7/12, u = -1$).

2) The case $W_4 > 0$. According to [8] in this case we have two foci if either $W_2 < 0$ or ($W_2 \geq 0$ and $W_1W_3 < 0$); and we have two nodes if $W_2 > 0$ and $W_1W_3 > 0$.

a) The subcase $W_2 < 0$ or ($W_2 \geq 0, W_1W_3 < 0$). We have two foci and for the existence of at least one weak focus, the condition $\mathcal{T}_4 = 0$ is necessary.

a₁) The possibility $\mathcal{T}_4 \neq 0$. Then both foci are strong. So considering Lemma 3.1 we arrive at the following 4 configurations

- $f, f, \overline{sn}_{(2)}; S, \odot, \odot$: Example \Rightarrow ((3.3) : $c = -2, e = 2/5, h = 1, m = 0, u = -2$) (if $\eta < 0$);
- $f, f, \overline{sn}_{(2)}; S, S, N^\infty$: Example \Rightarrow ((3.3) : $c = -2, e = 1/5, h = 1, m = 0, u = -2$) (if $\eta > 0$);
- $f, f, \overline{sn}_{(2)}; \binom{0}{2} SN, S$: Example \Rightarrow ((3.3) : $c = -2, e = \zeta, h = 1, m = 0, u = -2$) (where $\zeta = \eta^{-1}(0) \approx 0.38248$); (if $\eta = 0, \tilde{M} \neq 0$);

• $f, f, \overline{s\bar{n}}_{(2)}; \overline{\binom{0}{3}}S$: Example \Rightarrow ((3.3) : $c = -1, e = 1/2, h = 10/27, m = 1, u = -4/27$) (if $\eta = 0, \tilde{M} = 0$).

α_2) The possibility $\mathcal{T}_4 = 0$. Considering the condition $E_1 \neq 0$ and (3.5) we get $\rho_3\rho_4 = 0$. Then at least one focus is weak and without loss of generality we may assume that the singularity $M_3(1,0)$ is a weak focus, i.e. $m = (c - eu)/2$. In this case we obtain

$$\begin{aligned}\mathcal{T}_4 = 0, \quad \mathcal{T}_3 = -\Delta_3\Delta_4\rho_1^2\rho_4, \quad \mu_0 = u(ceu - c^2 + 2eh)^2 \\ \mathcal{F}_1 = u(ceu - c^2 + 2eh)(2c^2 + 3ce + 2eh + 2ceu + e^2u).\end{aligned}$$

α) The case $\mathcal{T}_3 \neq 0$. Then only the focus $M_3(1,0)$ is weak.

α_1) The subcase $\mathcal{F}_1 \neq 0$. By [28] the weak focus has order one and considering Lemma 3.1 we arrive at the following 4 configurations

• $f, f^{(1)}, \overline{s\bar{n}}_{(2)}; S, \odot, \odot$: Example \Rightarrow ((3.3) : $c = -1, e = 3, h = 1, m = 1, u = -1$) (if $\eta < 0$)

• $f, f^{(1)}, \overline{s\bar{n}}_{(2)}; S, S, N^\infty$: Example \Rightarrow ((3.3) : $c = -1, e = 8, h = 1, m = 7/2, u = -1$) (if $\eta > 0$);

• $f, f^{(1)}, \overline{s\bar{n}}_{(2)}; \overline{\binom{0}{2}}SN, S$: Example \Rightarrow ((3.3) : $c = -1, e = \xi, h = 1, m = (\xi - 1)/2, u = -1$) (where $\xi = \eta^{-1}(0) \approx 7.754938$) (if $\eta = 0, \tilde{M} \neq 0$);

• $f, f^{(1)}, \overline{s\bar{n}}_{(2)}; \overline{\binom{0}{3}}S$: Example \Rightarrow ((3.3) : $c = 1, e = -5, h = -2/5, m = -2, u = -1/25$) (if $\eta = 0, \tilde{M} = 0$).

α_2) The subcase $\mathcal{F}_1 = 0$. We claim that in this case if we have two foci (i.e. $\tau_3 < 0$ and $\tau_4 < 0$), then the condition $\eta < 0$ must hold. Indeed, since $\mu_0 \neq 0$ the condition $\mathcal{F}_1 = 0$ implies $2c^2 + 3ce + 2eh + 2ceu + e^2u = 0$. We observe that $e \neq 0$ otherwise $c = 0$ and this implies $\mu_0 = 0$. So we obtain $h = -(2c^2 + 3ce + 2ceu + e^2u)/(2e)$ and calculations yield

$$\begin{aligned}\eta = 4c(c+e)\Psi_1(c, e, u)/e^2, \quad \mu_0 = u(c+e)^2(3c+eu)^2, \\ \tau_3 = 4(c+e)(3c+eu), \quad \tau_4 = 4c(c+e)(c^2+ce+2ceu-e^2u+e^2u^2)/e^2,\end{aligned}$$

where $\Psi_1(c, e, u)$ is the polynomial from (3.7). Since the condition $\mu_0 < 0$ implies $u < 0$, it was shown in the proof of the statement (ii) of Lemma 3.5 (see page 27) that in this case $\text{sign}(\Psi_1) = 1$. Therefore $\text{sign}(\eta) = \text{sign}(c(c+e))$.

We observe that the conditions $c(c+e) > 0$ (i.e. $\eta > 0$) and $u < 0$ imply $c^2 + ce + 2ceu - e^2u + e^2u^2 > 0$. Indeed, if $ce < 0$ then we have

$$c^2 + ce + 2ceu - e^2u + e^2u^2 = c(c+e) - e^2u + e^2u^2 + 2ceu > 0$$

due to $c(c+e) > 0$ and $u < 0$. Assuming $ce > 0$ we have again

$$c^2 + ce + 2ceu - e^2u + e^2u^2 = ce - e^2u + (c+eu)^2 > 0.$$

So we get $\tau_4 > 0$ and this proves our claim.

Considering Lemma 3.5 (see the statement (ii)) we deduce that in this case the condition $\mathcal{F}_2 \neq 0$ must hold, i.e. by [28] the weak focus has order two. Thus considering Lemma 3.1 we get the configuration

• $f, f^{(2)}, \overline{s\bar{n}}_{(2)}; S, \odot, \odot$: Example \Rightarrow ((3.3) : $c = -1, e = 4, h = 9/4, m = 3/2, u = -1$).

β) The case $\mathcal{T}_3 = 0$. Then $\rho_3 = \rho_4 = 0$ and both elemental singularities are weak singularities (foci or centers). The condition $\rho_3 = \rho_4 = 0$ implies $m = (c - eu)/2$ and $h = (eu - c)/2$ and we calculate

$$\begin{aligned}\mu_0 = u(c+e)^2(c-eu)^2, \quad \mathcal{F}_1 = -2u(c+e)^2(c-eu)(c+eu), \\ E_1 = -u^2(c+e)^4(c-eu)^4(c+eu)/2\end{aligned}$$

and we arrive at the next remark.

Remark 3.7. if for a system (3.3) the conditions $\rho_3 = \rho_4 = 0$ and $E_1 \neq 0$ hold, then $\mathcal{F}_1 \tilde{M} \neq 0$.

Indeed, from the above expressions it immediately follows $\mathcal{F}_1 \neq 0$. On the other hand considering the relations $m = (c - eu)/2$ and $h = (eu - c)/2$ we calculate $\text{Coefficient}[\tilde{M}, xy] = -16(c + eu)^2 \neq 0$ due to $E_1 \neq 0$.

Therefore considering Lemma 3.1 we arrive at the following 3 configurations of singularities:

- $f^{(1)}, f^{(1)}, \overline{sn}_{(2)}; S, \odot, \odot$: Example \Rightarrow ((3.3) : $c = 1, e = -2, h = -3/8, m = 3/8, u = -1/8$) (if $\eta < 0$)
- $f^{(1)}, f^{(1)}, \overline{sn}_{(2)}; S, S, N^\infty$: Example \Rightarrow ((3.3) : $c = 4/15, e = -2, h = -1/120, m = 1/120, u = -1/8$) (if $\eta > 0$);
- $f^{(1)}, f^{(1)}, \overline{sn}_{(2)}; \binom{0}{2} SN, S$: Example \Rightarrow ((3.3) : $c = 5/16, e = -2, h = -1/32, m = 1/32, u = -1/8$) (if $\eta = 0$).

b) The subcase $W_2 > 0$ and $W_1 W_3 > 0$. We have two nodes which are generic due to $W_4 \neq 0$. So considering Lemma 3.1 we arrive at the following 4 configurations

- $n, n, \overline{sn}_{(2)}; S, \odot, \odot$: Example \Rightarrow ((3.3) : $c = 1, e = 1, h = 1, m = 0, u = -2$) (if $\eta < 0$);
- $n, n, \overline{sn}_{(2)}; S, S, N^\infty$: Example \Rightarrow ((3.3) : $c = 1, e = 3, h = 1, m = 0, u = -2$) (if $\eta > 0$);
- $n, n, \overline{sn}_{(2)}; \binom{0}{2} SN, S$: Example \Rightarrow ((3.3) : $c = 1, e = \zeta, h = 1, m = 0, u = -2$) (where $\zeta = \eta^{-1}(0) \approx 2.719192$) (if $\eta = 0, \tilde{M} \neq 0$);
- $n, n, \overline{sn}_{(2)}; \binom{0}{3} S$: Example \Rightarrow ((3.3) : $c = -1/2, e = -3/5, h = -5/6, m = 1, u = -25/35$) (if $\eta = 0, \tilde{M} = 0$).

3) The case $W_4 = 0$. Since $E_1 \neq 0$ (i.e. $\rho_1 \neq 0$) by (3.5) we obtain $\tau_3 \tau_4 = 0$ and therefore at least one elemental singular point is a node with coinciding eigenvalues and we may assume that such a singular point is $M_3(1, 0)$ (i.e. $\tau_3 = 0$). Considering [8] we examine three subcases: $W_3 < 0, W_3 > 0$ and $W_3 = 0$.

a) The subcase $W_3 < 0$. According to [8] the second elemental singularity is a focus. We claim that in this case we could not have a finite star node. Indeed, supposing that $M_3(1, 0)$ is a star node considering (3.4) we get $e = 0, h = -cu/2$ and $m = -c/2$. Then we calculate $W_3 = c^{14}u^2(1+u)^2 \geq 0$ which contradicts our assumption.

a₁) The possibility $\mathcal{T}_4 \neq 0$. In this case we have a strong focus and considering Lemma 3.1 we get the following 4 configurations:

- $n^d, f, \overline{sn}_{(2)}; S, \odot, \odot$: Example \Rightarrow ((3.3) : $c = 1, e = -1, h = 1/2, m = -1, u = -1$) (if $\eta < 0$);
- $n^d, f, \overline{sn}_{(2)}; S, S, N^\infty$: Example \Rightarrow ((3.3) : $c = 2, e = -1, h = -1/8, m = 0, u = -1$) (if $\eta > 0$);
- $n^d, f, \overline{sn}_{(2)}; \binom{0}{2} SN, S$: Example \Rightarrow ((3.3) : $c = 3, e = 0, h = 1, m = -3/2, u = -1$) (if $\eta = 0, \tilde{M} \neq 0$);
- $n^d, f, \overline{sn}_{(2)}; \binom{0}{3} S$: Example \Rightarrow ((3.3) : $c = -2, e = 0, h = 0, m = 1, u = -1$) (if $\eta = 0, \tilde{M} = 0$).

a₂) The possibility $\mathcal{T}_4 = 0$. Since $\tau_3 = 0$ we must have $\rho_3 \neq 0$ and then the condition $\mathcal{T}_4 = 0$ implies $\rho_4 = 0$. In this case we have a weak focus.

a) The case $\mathcal{F}_1 \neq 0$. The weak focus is of order one. Since $W_4 = 0$, by Lemma 3.5 (the statement (i) we have $\tilde{M} \neq 0$). So considering Lemma 3.1 we get the following 3 configurations:

- $n^d, f^{(1)}, \overline{sn}_{(2)}; S, \odot, \odot$: Example \Rightarrow ((3.3) : $c = -1, e = 1, h = 0, m = 2, u = -1$) (if $\eta < 0$);
- $n^d, f^{(1)}, \overline{sn}_{(2)}; S, S, N^\infty$: Example \Rightarrow ((3.3) : $c = -5, e = 1, h = 2, m = 0, u = -1$) (if $\eta > 0$);
- $n^d, f^{(1)}, \overline{sn}_{(2)}; \binom{0}{2}SN, S$: Example \Rightarrow ((3.3) : $c = -(16\xi^2 + 1)/4, e = (4\xi - 1)^2/4, h = \xi, m = (1 - 2\xi)/2, u = -1$) (where $\xi = \eta^{-1}(0) \approx -0.91591$) (if $\eta = 0$).

β) The case $\mathcal{F}_1 = 0$. Then the weak focus has at least order two.

β_1) The subcase $\mathcal{F}_2 \neq 0$. According to Lemma 3.5 (the statement (iv)) in this case the condition $\eta < 0$ holds and according to Lemma 3.1 we get the configuration

- $n^d, f^{(2)}, \overline{sn}_{(2)}; S, \odot, \odot$: Example \Rightarrow ((3.3) : $c = -2/5, e = 3/20, h = -2/5, m = 7/5, u = -8$).

β_2) The subcase $\mathcal{F}_2 = 0$. By Lemma 3.5 (the statement (iv)) in this case the conditions $\mathcal{F}_2 = \mathcal{F}_3 = 0$ and $\eta = 0$ are satisfied. Moreover, as it was shown in the proof of the statement (iv) (see page 29) for systems (3.3) the following conditions are fulfilled: $c = 0, m = -eu/2, h = -eu/2$. In this case we obtain

$$\mathcal{F}_1 = \mathcal{F}_2 = \mathcal{F}_3 = \mathcal{T}_4 = \eta = 0, \quad \mathcal{T}_3\mathcal{F} = e^{12}u^{11}/2, \quad \mu_0 = e^4u^3, \quad \tilde{M} = -8e^2u^2x^2$$

and as $\mu_0 < 0$ we get $\mathcal{T}_3\mathcal{F} < 0$ and $\tilde{M} \neq 0$. Therefore by [28, Main Theorem, statement (b₄)] besides the one-direction node we have a center and considering Lemma 3.1 we obtain the configuration

- $n^d, c, \overline{sn}_{(2)}; \binom{0}{2}SN, S$: Example \Rightarrow ((3.3) : $c = 0, e = 2, h = 1, m = 1, u = -1$).

b) The subcase $W_3 > 0$. According to [8] the second elemental singularity is a generic node.

b₁) The possibility $U_3 \neq 0$. In this case by Lemma 3.6 we cannot have a finite star node and considering Lemma 3.1 we get the following 4 configurations:

- $n, n^d, \overline{sn}_{(2)}; S, \odot, \odot$: Example \Rightarrow ((3.3) : $c = 2, e = 1, h = 9/8, m = 0, u = -1$) (if $\eta < 0$);
- $n, n^d, \overline{sn}_{(2)}; S, S, N^\infty$: Example \Rightarrow ((3.3) : $c = 0, e = 1, h = 1/8, m = 0, u = -1$) (if $\eta > 0$);
- $n, n^d, \overline{sn}_{(2)}; \binom{0}{2}SN, S$: Example \Rightarrow ((3.3) : $c = -2, e = 0, h = 4, m = 1, u = -1$) (if $\eta = 0, \tilde{M} \neq 0$);
- $n, n^d, \overline{sn}_{(2)}; \binom{0}{3}S$: Example \Rightarrow ((3.3) : $c = -2, e = 0, h = 0, m = 1, u = -1/5$) (if $\eta = 0, \tilde{M} = 0$).

b₂) The possibility $U_3 = 0$. By Lemma 3.6 we have one finite star node (which is unique) and in this case the condition $\tilde{M} \neq 0$ holds. Hence by Lemma 3.1 we get the configuration

- $n, n^*, \overline{sn}_{(2)}; \binom{0}{2}SN, S$: Example \Rightarrow ((3.3) : $c = 2, e = 0, h = 2, m = -1, u = -2$).

c) The subcase $W_3 = 0$. In this case we have $\tau_3 = \tau_4 = 0$, i.e. each one of the nodes has coinciding eigenvalues.

c₁) The possibility $U_3 \neq 0$. In this case by Lemma 3.6 we cannot have a star node and considering Lemma 3.1 we get the following 4 configurations:

- $n^d, n^d, \overline{sn}_{(2)}; S, \odot, \odot$: Example \Rightarrow ((3.3) : $c = 2, e = -2, h = -5, m = 1, u = -4$) (if $\eta < 0$);
- $n^d, n^d, \overline{sn}_{(2)}; S, S, N^\infty$: Example \Rightarrow ((3.3) : $c = 2, e = -1/2, h = 3/4, m = -3/4, u = -1$) (if $\eta > 0$);

- $n^d, n^d, \overline{sn}_{(2)}; \binom{0}{2} SN, S$: Example \Rightarrow ((3.3) : $c = -1, e = 0, h = -1, m = 1/2, u = -9/4$) (if $\eta = 0, \tilde{M} \neq 0$);

- $n^d, n^d, \overline{sn}_{(2)}; \binom{0}{3} S$: Example \Rightarrow ((3.3) : $c = 1, e = 0, h = 0, m = -1/2, u = -1/4$) (if $\eta = 0, \tilde{M} = 0$).

c₂) The possibility $U_3 = 0$. By Lemma 3.6 one of the nodes is a star node. We may assume $M_3(1,0)$ to be a star node, i.e. the conditions $e = 0, h = -cu/2$ and $m = -c/2$ hold. In this case we calculate $\mu_0 = c^4 u W_3 = c^{14} u^2 (1+u)^2$ and due to $\mu_0 < 0$ the condition $W_3 = 0$ gives $u = -1$. So and we get the configuration

- $n^d, n^*, \overline{sn}_{(2)}; \binom{0}{2} SN, S$: Example \Rightarrow ((3.3) : $c = -1, e = 0, h = -1/2, m = 1/2, u = -1$).

The possibility $E_1 = 0$ In this case $\rho_1 = 0$ and besides two anti-saddles we have a cusp. Then $c = -eu$ and by (3.5) we obtain

$$\begin{aligned} W_4 = W_3 = 0, \quad W_2 = \Delta_3^2 \Delta_4^2 \tau_3 \tau_4, \quad W_1 = \Delta_3^2 \Delta_4^2 (\tau_3 + \tau_4), \\ \mathcal{T}_4 = \mathcal{T}_3 = 0, \quad \mathcal{T}_2 = -\Delta_3 \Delta_4 \rho_3 \rho_4, \quad \mathcal{T}_1 = -\Delta_3 \Delta_4 (\rho_3 + \rho_4). \end{aligned}$$

1) The case $W_2 < 0$. According to [8, Table 1, line 74] we have a node and a focus. Moreover, the node is generic, whereas the type of the focus depends on the invariant polynomial \mathcal{T}_2 .

a) The subcase $\mathcal{T}_2 \neq 0$. The focus is strong and considering Lemma 3.1 we arrive at the following 4 configurations

- $n, f, \widehat{cp}_{(2)}; S, \odot, \odot$: Example \Rightarrow ((3.3) : $c = 1, e = 1, h = 1, m = 0, u = -1$) (if $\eta < 0$)
- $n, f, \widehat{cp}_{(2)}; S, S, N^\infty$: Example \Rightarrow ((3.3) : $c = -3/2, e = -1, h = 2, m = 2, u = -3/2$) (if $\eta > 0$);

- $n, f, \widehat{cp}_{(2)}; \binom{0}{2} SN, S$: Example \Rightarrow ((3.3) : $c = \xi, e = -1, h = 2, m = 2, u = \xi$) (where $\xi = \eta^{-1}(0) \approx -1.5278$) (if $\eta = 0, \tilde{M} \neq 0$);

- $n, f, \widehat{cp}_{(2)}; \binom{0}{3} S$: Example \Rightarrow ((3.3) : $c = 8, e = 1, h = 28, m = -10, u = -8$) (if $\eta = 0, \tilde{M} = 0$).

b) The subcase $\mathcal{T}_2 = 0$. Then the focus is weak and without loss of generality we may assume that the singularity $M_3(1,0)$ is a weak focus, i.e. $m = (c - eu)/2$ and since $c = -eu$ we get $m = -eu$. We calculate

$$\mu_0 = 4e^2 u (h - eu^2)^2, \quad \mathcal{F}_1 = 4e^2 u (h - eu)(h - eu^2),$$

We remark that in this case the condition $\mathcal{F}_1 \neq 0$ holds, otherwise we get $h = eu$ and then we calculate $W_2 = -2^{10} e^{12} (1-u)^6 u^9 > 0$ due to $\mu_0 = 4e^4 (u-1)^2 u^3 < 0$.

Thus in this case by [28] we have a first order weak focus. Since by Lemma 3.5 (the statement (i)) the condition $\tilde{M} \neq 0$ holds, according to Lemma 3.1 we arrive at the following 3 configurations

- $n, f^{(1)}, \widehat{cp}_{(2)}; S, \odot, \odot$: Example \Rightarrow ((3.3) : $c = 1, e = 1, h = 2, m = 1, u = -1$) (if $\eta < 0$)

- $n, f^{(1)}, \widehat{cp}_{(2)}; S, S, N^\infty$: Example \Rightarrow ((3.3) : $c = 1, e = 1, h = 6/5, m = 1, u = -1$) (if $\eta > 0$);

- $n, f^{(1)}, \widehat{cp}_{(2)}; \binom{0}{2} SN, S$: Example \Rightarrow ((3.3) : $c = 1, e = 1, h = \xi, m = 1, u = -1$) (where $\xi = \eta^{-1}(0) \approx 1.311184$) (if $\eta = 0$).

2) The case $W_2 > 0$. According to [8, Table 1, line 73] we have two nodes and both are generic and considering Lemma 3.1 we arrive at the following 4 configurations:

- $n, n, \widehat{c}p_{(2)}; S, \odot, \odot$: Example \Rightarrow ((3.3) : $c = 3, e = 3, h = 3/2, m = 1, u = -1$) (if $\eta < 0$);
- $n, n, \widehat{c}p_{(2)}; S, S, N^\infty$: Example \Rightarrow ((3.3) : $c = 3, e = 3, h = 21/20, m = 1, u = -1$) (if $\eta > 0$);
- $n, n, \widehat{c}p_{(2)}; \binom{0}{2}SN, S$: Example \Rightarrow ((3.3) : $c = 3, e = 3, h = \xi, m = 1, u = -1$) (where $\xi = \eta^{-1}(0) \approx 1.090358$) (if $\eta = 0, \widetilde{M} \neq 0$);
- $n, n, \widehat{c}p_{(2)}; \binom{0}{3}S$: Example \Rightarrow ((3.3) : $c = 1, e = 1, h = 2, m = -2, u = -1$) (if $\eta = 0, \widetilde{M} = 0$).

3) The case $W_2 = 0$. According to [8, Table 1, line 73] we have two nodes and at least one is with coinciding eigenvalues. Since $E_1 = 0$, by Lemma 3.6 we could not have a finite star node.

We assume that the singular point $M_3(1, 0)$ is a point with coinciding eigenvalues. So we impose $\tau_3 = 0$ and since $\rho_1 = 0$ (due to $E_1 = 0$) by (3.5) we obtain $W_1 = \Delta_3^2 \Delta_4^2 \tau_4$.

a) The subcase $W_1 \neq 0$. Then $\tau_4 \neq 0$ and hence the second node is generic. So considering Lemma 3.1 we arrive at the following 4 configurations

- $n, n^d, \widehat{c}p_{(2)}; S, \odot, \odot$: Example \Rightarrow ((3.3) : $c = 1, e = 1, h = 1/2, m = 0, u = -1$) (if $\eta < 0$);
- $n, n^d, \widehat{c}p_{(2)}; S, S, N^\infty$: Example \Rightarrow ((3.3) : $c = 1, e = 1, h = 5/2, m = 2, u = -1$) (if $\eta > 0$);
- $n, n^d, \widehat{c}p_{(2)}; \binom{0}{2}SN, S$: Example \Rightarrow ((3.3) : $c = 1, e = 1, h = (1 + \xi^2)/2, m = \xi, u = -1$) (where $\xi = \eta^{-1}(0) \approx 0.5694$) (if $\eta = 0, \widetilde{M} \neq 0$);
- $n, n^d, \widehat{c}p_{(2)}; \binom{0}{3}S$: Example \Rightarrow ((3.3) : $c = 64/125, e = 1, h = 544/625, m = -152/125, u = -4/5$) (if $\eta = 0, \widetilde{M} = 0$).

b) The subcase $W_1 = 0$. Then $\tau_4 = 0$ and hence the singular point $M_4(0, 1)$ is a node with coinciding eigenvalues. It was shown above that none of the nodes could be a star node.

We claim that in this case the condition $\eta < 0$ holds. Indeed considering the relations $c = -eu$ and $h = (m^2 + e^2u^2)/(2e)$ we calculate

$$\tau_4 = (m^4 + 4e^4u^2 + 8e^3mu^2 + 2e^2m^2u^2 + e^4u^4)/e^2 \equiv \phi(e, m, u)/e^2.$$

Consider the equation $\phi(e, m, u) = 0$. We observe that the polynomial ϕ is homogeneous of degree 4 with respect to c and m and it is bi-quadratic in u . So denoting $m/e = z$ we calculate $\text{Discrim}[\phi(1, z, u), u^2] = 16(1+z)^2(1+2z)$ and clearly the condition $(1+z)^2(1+2z) \geq 0$ must hold.

Assume $1+z \neq 0$. Then $1+2z \geq 0$ and setting a new variable w as follows: $1+2z = w^2 \geq 0$ (i.e. $z = (w^2 - 1)/2$) we calculate

$$\phi(1, z, u) = [4u^2 + (w-1)^4][4u^2 + (w+1)^4].$$

It is clear that the condition $u \neq 0$ implies $\phi(1, z, u) \neq 0$.

Suppose now $z = -1$. This yields $m = -e$ and then we have

$$\phi(e, -e, u) = e^2(u^2 - 1)^2 = 0.$$

Since $\mu_0 < 0$ (i.e. $u < 0$) we get $u = -1$ and then we calculate

$$\tau_3 = \tau_4 = 0, \quad \eta = -16e^4 = \mu_0$$

and as $\mu_0 < 0$ this completes the proof of our claim.

Thus in the case $W_2 = W_1 = 0$ we get the unique configuration

- $n^d, n^d, \widehat{c}p_{(2)}; S, \odot, \odot$: Example \Rightarrow ((3.3) : $c = 1, e = 1, h = 1, m = -1, u = -1$).

3.2.2 The case $\mu_0 > 0$

Following [8] we shall consider two subcases: $E_1 \neq 0$ and $E_1 = 0$.

The subcase $E_1 \neq 0$ Then the double singular point is a semi-elemental saddle-node.

The possibility $W_4 < 0$. According to [8] besides the saddle-node we have a saddle and a focus. Moreover by [28] their types depend on the invariant polynomials \mathcal{T}_i and \mathcal{F}_i ($i = 1, \dots, 4$).

1) *The case $\mathcal{T}_4 \neq 0$.* Then $\rho_3\rho_4 \neq 0$ and both elemental singularities are strong.

a) *The subcase $\eta < 0$.* Then systems (3.3) possess one real and two complex infinite singular points and according to Lemmas 3.1 and 3.5 (the statement (iii)) there can only be 3 distinct configurations at infinity:

- $s, f, \overline{sn}_{(2)}; N^\infty, \textcircled{C}, \textcircled{C}$: Example \Rightarrow ((3.3) : $c = 2, e = 1/2, h = 1, m = 0, u = 1$) (if $\theta < 0$);
- $s, f, \overline{sn}_{(2)}; N^f, \textcircled{C}, \textcircled{C}$: Example \Rightarrow ((3.3) : $c = 0, e = 1, h = 1, m = 0, u = 1$) (if $\theta > 0$);
- $s, f, \overline{sn}_{(2)}; N^d, \textcircled{C}, \textcircled{C}$: Example \Rightarrow ((3.3) : $c = 2, e = 1, h = 1, m = 0, u = 1$) (if $\theta = 0$).

b) *The subcase $\eta > 0$.* In this case systems (3.3) possess three real infinite singular points. Since for these systems the condition $\mu_0 > 0$ holds, taking into consideration Lemmas 3.1 and 3.5 (the statement (iii)) we could have at infinity only 6 distinct configurations. The corresponding examples are:

- $s, f, \overline{sn}_{(2)}; S, N^\infty, N^\infty$: Example \Rightarrow ((3.3) : $c = 2, e = 2/5, h = -2/5, m = -8/5, u = 1$) (if $\theta < 0, \theta_1 < 0$);
- $s, f, \overline{sn}_{(2)}; S, N^f, N^f$: Example \Rightarrow ((3.3) : $c = 1/2, e = 1, h = 0, m = -2, u = 2$) (if $\theta < 0, \theta_1 > 0$);
- $s, f, \overline{sn}_{(2)}; S, N^\infty, N^f$: Example \Rightarrow ((3.3) : $c = -3/2, e = 1/2, h = 0, m = -2, u = 2$) (if $\theta > 0$);
- $s, f, \overline{sn}_{(2)}; S, N^\infty, N^d$: Example \Rightarrow ((3.3) : $c = 6/5, e = 1/5, h = 1, m = 0, u = 1$) (if $\theta = 0, \theta_1 < 0$);
- $s, f, \overline{sn}_{(2)}; S, N^f, N^d$: Example \Rightarrow ((3.3) : $c = 1/4, e = 1/2, h = -1/4, m = 0, u = 1/4$) (if $\theta = 0, \theta_1 > 0$);
- $s, f, \overline{sn}_{(2)}; S, N^d, N^d$: Example \Rightarrow ((3.3) : $c = -3, e = -1, h = 2, m = 3, u = 2$) (if $\theta = 0, \theta_1 = 0$).

c) *The subcase $\eta = 0$.* In this case systems (3.3) possess at infinity either one double and one simple real singular points (if $\tilde{M} \neq 0$) or one triple real singularity (if $\tilde{M} = 0$). So by Lemmas 3.1 and 3.5 (the statement (iii)) we have the following 4 configurations:

- $s, f, \overline{sn}_{(2)}; \binom{0}{2}SN, N^\infty$: Example \Rightarrow (S_3) : ((3.3) : $c = 0, d = -1, e = 1, f = 1, g = 2, h = 1$) (if $\theta < 0$);
- $s, f, \overline{sn}_{(2)}; \binom{0}{2}SN, N^f$: Example \Rightarrow (S_3) : ((3.3) : $c = 1, d = 0, e = 1, f = 0, g = 1/2, h = 1$) (if $\theta > 0$);
- $s, f, \overline{sn}_{(2)}; \binom{0}{2}SN, N^d$: Example \Rightarrow (S_3) : ($c = 1, d = 0, e = 1, f = 0, g = 1, h = 1$) (if $\theta = 0$),

if $\tilde{M} \neq 0$ and one configuration

- $s, f, \overline{sn}_{(2)}; \binom{0}{3}N$: Example \Rightarrow (S_4) : ((3.3) : $c = 0, d = -1, e = 0, f = 2, g = 1, h = -1$) if $\tilde{M} = 0$.

2) The case $\mathcal{T}_4 = 0$. Considering the condition $E_1 \neq 0$ and (3.5) we get $\rho_3\rho_4 = 0$. Then at least one singularity is weak and without loss of generality we may assume that such a singularity is $M_3(1, 0)$.

a) The subcase $\mathcal{T}_3 \neq 0$. In this case only one singularity is weak and considering the condition $\rho_3 = 0$ (i.e. $m = (c - eu)/2$) we calculate

$$\begin{aligned}\mu_0 &= u(c^2 - 2eh - ceu)^2, \quad \mathcal{T}_3 = u(c + eu)^2(c + 2h - eu)(c^2 - 2eh - ceu)^2, \\ \mathcal{T}_3\mathcal{F} &= u^2(c + eu)^4(c + 2h - eu)^2(c^2 - 2eh - ceu)^3/8.\end{aligned}$$

We observe that the condition $\mathcal{T}_3 \neq 0$ implies $\mathcal{T}_3\mathcal{F} \neq 0$ and we consider two possibilities: $\mathcal{T}_3\mathcal{F} < 0$ and $\mathcal{T}_3\mathcal{F} > 0$.

α_1) The possibility $\mathcal{T}_3\mathcal{F} < 0$. According to [28, Main Theorem, the statement (b)] the weak singularity is a focus.

α) The case $\mathcal{F}_1 \neq 0$. Then the order of the weak focus is one.

α_1) The subcase $\eta < 0$. According to Lemma 3.5 (the statement (iii)) the condition $\theta = \theta_2 = 0$ could not be satisfied. So by Lemma 3.1 there can only be 3 distinct configurations at infinity:

- $s, f^{(1)}, \overline{s\bar{n}}_{(2)}; N^\infty, \odot, \odot$: Example \Rightarrow ((3.3) : $c = -3, e = -2, h = -1, m = -1/2, u = 1$) (if $\theta < 0$);
- $s, f^{(1)}, \overline{s\bar{n}}_{(2)}; N^f, \odot, \odot$: Example \Rightarrow ((3.3) : $c = -1, e = -3, h = 0, m = 1, u = 1$) (if $\theta > 0$);
- $s, f^{(1)}, \overline{s\bar{n}}_{(2)}; N^d, \odot, \odot$: Example \Rightarrow ((3.3) : $c = 1, e = 2, h = 1/2, m = 3/2, u = 1$) (if $\theta = 0$).

α_2) The subcase $\eta > 0$. In this case systems (3.1) possess three real infinite singular points. Since for these systems the condition $\mu_0 > 0$ holds, taking into consideration Lemmas 3.1 and 3.5 (the statement (iii)) we could have at infinity only the following 6 distinct configurations:

- $s, f^{(1)}, \overline{s\bar{n}}_{(2)}; S, N^\infty, N^\infty$: Example \Rightarrow ((3.3) : $c = 7/2, e = 1, h = 4, m = 1, u = 3/2$) (if $\theta < 0, \theta_1 < 0$);
- $s, f^{(1)}, \overline{s\bar{n}}_{(2)}; S, N^f, N^f$: Example \Rightarrow ((3.3) : $c = -1/2, e = 1, h = 3/2, m = -5/2, u = 9/2$) (if $\theta < 0, \theta_1 > 0$);
- $s, f^{(1)}, \overline{s\bar{n}}_{(2)}; S, N^\infty, N^f$: Example \Rightarrow ((3.3) : $c = -3/2, e = 1, h = 4, m = -5/2, u = 7/2$) (if $\theta > 0$);
- $s, f^{(1)}, \overline{s\bar{n}}_{(2)}; S, N^\infty, N^d$: Example \Rightarrow ((3.3) : $c = 1/4, e = 7/4, h = 3/32, m = 13/16, u = 1/4$) (if $\theta = 0, \theta_1 < 0$);
- $s, f^{(1)}, \overline{s\bar{n}}_{(2)}; S, N^f, N^d$: Example \Rightarrow ((3.3) : $c = 1/4, e = -1/4, h = -5/32, m = 3/16, u = 1/4$) (if $\theta = 0, \theta_1 > 0$);
- $s, f^{(1)}, \overline{s\bar{n}}_{(2)}; S, N^d, N^d$: Example \Rightarrow ((3.3) : $c = 3/10, e = 1, h = -1/10, m = -3/10, u = 1/10$) (if $\theta = 0, \theta_1 = 0$).

α_3) The subcase $\eta = 0$. In this case systems (3.1) possess at infinity either one double and one simple real singular points (if $\tilde{M} \neq 0$) or one triple real singularity (if $\tilde{M} = 0$). So by Lemmas 3.1 and 3.5 (the statement (iii)) we have the following 4 configurations:

- $s, f^{(1)}, \overline{s\bar{n}}_{(2)}; \binom{0}{2}SN, N^\infty$: Example \Rightarrow ((3.3) : $c = 3/2, e = 1/42, h = -7, m = -1, u = 147$) (if $\theta < 0$);
- $s, f^{(1)}, \overline{s\bar{n}}_{(2)}; \binom{0}{2}SN, N^f$: Example \Rightarrow ((3.3) : $c = 50, e = \xi, h = -58, m = (50 - 8\xi)/2, u = 8$) (where $\xi = \eta^{-1}(0) \approx 44.635072$) (if $\theta > 0$);
- $s, f^{(1)}, \overline{s\bar{n}}_{(2)}; \binom{0}{2}SN, N^d$: Example \Rightarrow ((3.3) : $c = \xi, e = \chi, h = \frac{1+4\xi^2-32\xi\chi}{8\chi}, m = (\xi - 8\chi)/2, u = 8$) (where $(\xi, \chi) = (\eta^{-1}(0), \theta^{-1}(0)) \approx (1.1776729, 0.1071644)$) (if $\theta = 0$),

if $\tilde{M} \neq 0$ and one configuration

• $s, f^{(1)}, \overline{sn}_{(2)}; \binom{0}{3}N$: Example \Rightarrow ((3.3) : $c = -3, e = -1/405, h = -65, m = 1, u = 2025$)
if $\tilde{M} = 0$.

β) The case $\mathcal{F}_1 = 0$. We claim that in this case the condition $e \neq 0$ holds. Indeed, since the condition $\rho_3 = 0$ gives $m = (c - eu)/2$, supposing $e = 0$ we obtain $\mu_0 = c^4u > 0$ and then $\mathcal{F}_1 = -2c^4u \neq 0$. So $e \neq 0$ and due to a time rescaling we may assume $e = 1$. In this case we calculate

$$\mathcal{F}_1 = u(cu - c^2 + 2h)(3c + 2c^2 + 2h + u + 2cu), \quad \mu_0 = u(cu - c^2 + 2h)^2$$

and as $\mu_0 \neq 0$ the condition $\mathcal{F}_1 = 0$ implies $h = -(3c + 2c^2 + u + 2cu)/2$. Then we have

$$\begin{aligned} \mu_0 &= u(c+1)^2(3c+u)^2, & \mathcal{F}_2 &= -c(1+c)^4u^2(c+u)^4(3c+u)^2(6c+u), \\ \eta &= 4c(c+1)\Psi_2(c,u), & \theta &= -8(1+c)(3c+u)\Psi_3(c,u), & \tau_3 &= 4(c+1)(3c+u), \\ \tau_4 &= 4c(1+c)[(c+u)^2 + c - u], & E_1 &= -(1+c)^4u^2(c+u)(3c+u)^4/2, \end{aligned} \quad (3.10)$$

where

$$\begin{aligned} \Psi_2(c,u) &= 12c^4 + u^4 + 3cu^2(3+2u) + 4c^3(9+7u) + 3c^2(9+6u+7u^2), \\ \Psi_3(c,u) &= 4c^4 + 2c(u-3)u - (u-1)u^2 + 4c^3(3+2u) + c^2(9-u+4u^2). \end{aligned}$$

Lemma 3.8. Assume that the conditions $\mu_0 > 0, E_1 \neq 0, \mathcal{T}_4 = \mathcal{F}_1 = 0$ and $W_4 < 0$ hold. Then we have: (i) $\tilde{M} \neq 0$; (ii) the condition $\eta = 0$ implies $\theta > 0$; (iii) if in addition $\mathcal{T}_3\mathcal{F} < 0$ then (iii₁) the condition $\eta < 0$ implies $\theta > 0$ and (iii₂) the conditions $\eta > 0$ and $\theta \leq 0$ imply $\theta_1 > 0$.

Proof. Since $\mu_0 E_1 \neq 0$ the condition $\mathcal{T}_4 = 0$ gives $\rho_3 \rho_4 = 0$ and we may consider $\rho_3 = 0$. Then forcing the condition $\mathcal{F}_1 = 0$ we have $e \neq 0$ (we may assume $e = 1$ as it is mentioned above) and $h = -(3c + 2c^2 + u + 2cu)/2$ and we arrive at the relations (3.10).

(i) Suppose that the condition $\tilde{M} = 0$ holds. We calculate $\text{Coefficient}[\tilde{M}, xy] = -16c(3 + 2c - u)(c + u)xy$ and as $E_1 \tau_4 \neq 0$ the condition $\tilde{M} = 0$ implies $3 + 2c - u = 0$, i.e. $u = 3 + 2c$. Then we obtain $\tilde{M} = -72(1+c)(1+2c)(x^2 + 3cy^2 + 2c^2y^2)$. Hence the condition $\tilde{M} = 0$ yields $c = -1/2$ and this implies $\tau_3 \tau_4 = 1/4 > 0$, i.e. we get a contradiction.

(ii) Assume that the condition $\eta = 0$ is fulfilled. The only intersection of the curves $\eta = 0$ and $\theta = 0$ outside the union $\{\mu_0 = 0, E_1 = 0, W_4 = 0\}$ is the point $(c_0, u_0) \approx (-0.5745, 2.1564)$ for which $W_4 > 0$. In any other open subset of the region \mathfrak{R} defined by $\{\mu_0 > 0, E_1 \neq 0, W_4 < 0\}$ these curves do not intersect. So when $\eta = 0$ the polynomial θ has a fixed sign which could be different if \mathfrak{R} is disconnected. Checking the sign of θ on the points of the curve $\eta = 0$ in any subset of \mathfrak{R} we detect that θ is always positive.

(iii) Assume now that the condition $\mathcal{T}_3\mathcal{F} < 0$ holds. Due to $\rho_3 = 0$ this is equivalent to $\tau_3 < 0$ (as we have a weak focus).

(iii₁) As we mentioned above the only intersection of the curves $\eta = 0$ and $\theta = 0$ outside the union $\{\mu_0 = 0, E_1 = 0, W_4 = 0\}$ is in the domain $W_4 > 0$ where we also have $\tau_3 > 0$. On the other hand inside the intersection of the region \mathfrak{R} with the region defined by $\tau_3 < 0$ we can have either $\eta > 0$ or $\eta \leq 0$ (respectively $\theta > 0$ or $\theta \leq 0$). But since there is no intersection of these curves it means that some combinations of signs is not possible. It remains to observe that in the domain $\eta < 0$ we have $\theta > 0$.

(iii₂) Considering the intersection points of the curve $\theta_1 = 0$ with $\theta = 0$ (respectively with $\eta = 0$) we detect that they are also in the complement of the region of $\tau_3 < 0$ and $\mu_0 > 0$.

Moreover in this region the curve $\theta_1 = 0$ is located on the domain where $\eta > 0$ and $\theta > 0$. It remains to observe that in the region where $\theta < 0$ we have $\theta_1 > 0$. This completes the proof of the lemma. \square

We consider two subcases: $\mathcal{F}_2 \neq 0$ and $\mathcal{F}_2 = 0$.

β_1) The subcase $\mathcal{F}_2 \neq 0$. In this case the weak focus is of order two and by the above remark and Lemma 3.1 we arrive at the following configurations of singularities:

- $s, f^{(2)}, \overline{s\bar{n}}_{(2)}; N^f, \odot, \odot$: Example \Rightarrow ((3.3) : $c = -1/2, e = 1, h = 1/2, m = -3/8, u = 1/4$) (if $\eta < 0$);

- $s, f^{(2)}, \overline{s\bar{n}}_{(2)}; S, N^f, N^f$: Example \Rightarrow ((3.3) : $c = -3/2, e = 1, h = 5, m = -13/4, u = 5$) (if $\eta > 0, \theta < 0$);

- $s, f^{(2)}, \overline{s\bar{n}}_{(2)}; S, N^\infty, N^f$: Example \Rightarrow ((3.3) : $c = -3, e = 1, h = 41/2, m = -13/2, u = 10$) (if $\eta > 0, \theta > 0$);

- $s, f^{(2)}, \overline{s\bar{n}}_{(2)}; S, N^f, N^d$: Example \Rightarrow ((3.3) : $c = \zeta, e = 1, h = -(2\zeta^2 + 23\zeta + 10)/2, m = (\zeta - 10)/2, u = 10$) (where $\zeta = \theta^{-1}(0) \approx -2.6027488$) (if $\eta > 0, \theta = 0$);

- $s, f^{(2)}, \overline{s\bar{n}}_{(2)}; \binom{0}{2} SN, N^f$: Example \Rightarrow ((3.3) : $c = -4/5, e = 1, h = (28 + 15\zeta)/50, m = -(4 + 5\zeta)/10, u = \zeta$) (where $\zeta = \eta^{-1}(0) \approx 2.23643428$) (if $\eta = 0$).

β_2) The subcase $\mathcal{F}_2 = 0$. Considering (3.10) and the condition $E_1\tau_4 \neq 0$ we get $(6c + u) = 0$, i.e. $c = -u/6$. Calculations yield:

$$\begin{aligned} \mathcal{T}_4 = \mathcal{F}_1 = \mathcal{F}_2 = 0, \quad \tau_3 = u(6 - u)/3, \quad \eta = u^3(u - 6)(81 - 126u + 50u^2)/972, \\ \mathcal{F}_3\mathcal{F}_4 = 5^7 2^{-17} 3^{-19} u^{19} (u - 6)^8, \quad \theta = u^3(u - 6)(729 - 459u + 25u^2)/486 \end{aligned} \quad (3.11)$$

and clearly the conditions $\tau_3 < 0$ and $u > 0$ (due to $\mu_0 > 0$) imply $u > 6, \eta > 0$ and $\mathcal{F}_3\mathcal{F}_4 \neq 0$. Hence we could not have a center in this case. Considering Lemma 3.8 and Lemma 3.1 we arrive at the following configurations of singularities:

- $s, f^{(3)}, \overline{s\bar{n}}_{(2)}; S, N^f, N^f$: Example \Rightarrow ((3.3) : $c = -2, e = 1, h = 17, m = -7, u = 12$) (if $\theta < 0$);

- $s, f^{(3)}, \overline{s\bar{n}}_{(2)}; S, N^\infty, N^f$: Example \Rightarrow ((3.3) : $c = -3, e = 1, h = 81/2, m = -21/2, u = 18$) (if $\theta > 0$);

- $s, f^{(3)}, \overline{s\bar{n}}_{(2)}; S, N^f, N^d$: Example \Rightarrow ((3.3) : $c = -\zeta/6, e = 1, h = \zeta(5\zeta - 9)/36, m = -7\zeta/12, u = \zeta$) (where $\zeta = 27(17 + 3\sqrt{21})/50$) (if $\theta = 0$).

α_2) The possibility $\mathcal{T}_3\mathcal{F} > 0$. According to [28] the weak singularity is a saddle.

α) The case $\mathcal{F}_1 \neq 0$. Then the order of the weak saddle is one.

α_1) The subcase $\eta < 0$. According to Lemmas 3.5 (the statement (iii)) and 3.1 there can only be 3 distinct configurations at infinity:

- $s^{(1)}, f, \overline{s\bar{n}}_{(2)}; N^\infty, \odot, \odot$: Example \Rightarrow ((3.3) : $c = 2, e = 4, h = -2, m = -1, u = 1$) (if $\theta < 0$);

- $s^{(1)}, f, \overline{s\bar{n}}_{(2)}; N^f, \odot, \odot$: Example \Rightarrow ((3.3) : $c = 2, e = 2, h = -2, m = 0, u = 1$) (if $\theta > 0$);

- $s^{(1)}, f, \overline{s\bar{n}}_{(2)}; N^d, \odot, \odot$: Example \Rightarrow ((3.3) : $c = 2, e = 10/3, h = -2, m = -2/3, u = 1$) (if $\theta = 0$).

α_2) The subcase $\eta > 0$. In this case systems (3.1) possess three real infinite singular points. Since for these systems the condition $\mu_0 > 0$ holds, taking into consideration Lemmas 3.1 and 3.5 (the statement (iii)) we could have at infinity only the following 6 distinct configurations:

- $s^{(1)}, f, \overline{s\bar{n}}_{(2)}; S, N^\infty, N^\infty$: Example \Rightarrow ((3.3) : $c = 3, e = 17/2, h = -8, m = -11/4, u = 1$) (if $\theta < 0, \theta_1 < 0$);

- $s^{(1)}, f, \overline{sn}_{(2)}; S, N^f, N^f$: Example \Rightarrow ((3.3) : $c = -5/2, e = -1, h = 3, m = -1, u = 1/2$) (if $\theta < 0, \theta_1 > 0$);
- $s^{(1)}, f, \overline{sn}_{(2)}; S, N^\infty, N^f$: Example \Rightarrow ((3.3) : $c = 3, e = 8, h = -8, m = -5/2, u = 1$) (if $\theta > 0$);
- $s^{(1)}, f, \overline{sn}_{(2)}; S, N^\infty, N^d$: Example \Rightarrow ((3.3) : $c = 2, e = 40, h = -9, m = -4, u = 1/4$) (if $\theta = 0, \theta_1 < 0$);
- $s^{(1)}, f, \overline{sn}_{(2)}; S, N^f, N^d$: Example \Rightarrow ((3.3) : $c = 4, e = 40, h = -21/2, m = -3, u = 1/4$) (if $\theta = 0, \theta_1 > 0$);
- $s^{(1)}, f, \overline{sn}_{(2)}; S, N^d, N^d$: Example \Rightarrow ((3.3) : $c = -1, e = -12, h = 3, m = 1, u = 1/4$) (if $\theta = 0, \theta_1 = 0$).

α_2) The subcase $\eta = 0$. In this case systems (3.1) possess at infinity either one double and one simple real singular points (if $\tilde{M} \neq 0$) or one triple real singularity (if $\tilde{M} = 0$). So by Lemmas 3.1 and 3.5 (the statement (iii)) we have the following 4 configurations:

- $s^{(1)}, f, \overline{sn}_{(2)}; \binom{0}{2}SN, N^\infty$: Example \Rightarrow ((3.3) : $c = 1/2, e = 27/10, h = -5/3, m = -1, u = 25/27$) (if $\theta < 0$);
- $s^{(1)}, f, \overline{sn}_{(2)}; \binom{0}{2}SN, N^f$: Example \Rightarrow ((3.3) : $c = \xi, e = 1, h = -2, m = (\xi - 1)/2, u = 1$) (where $\xi = \eta^{-1}(0) \approx 1.137298$) (if $\theta > 0$);
- $s^{(1)}, f, \overline{sn}_{(2)}; \binom{0}{2}SN, N^d$: Example \Rightarrow ((3.3) : $c = \xi, e = \chi, h = -2, m = (\xi - \chi)/2, u = 1$) (where $(\xi, \chi) = (\eta^{-1}(0), \theta^{-1}(0)) \approx (0.824045, 2.1573787)$) (if $\theta = 0$),
if $\tilde{M} \neq 0$ and one configuration
- $s^{(1)}, f, \overline{sn}_{(2)}; \binom{0}{3}N$: Example \Rightarrow ((3.3) : $c = 3/4, e = -1331/1620, h = -10/11, m = 1, u = 2025/1331$)
if $\tilde{M} = 0$.

β) The case $\mathcal{F}_1 = 0$. Then the order of the weak saddle is at least two. In this case by Lemma 3.8 we have $\tilde{M} \neq 0$ (i.e. at infinity we could not have a triple singularity) and the condition $\eta = 0$ implies $\theta > 0$ (see the statement (ii) of this lemma).

We consider two subcases: $\mathcal{F}_2 \neq 0$ and $\mathcal{F}_2 = 0$.

β_1) The subcase $\mathcal{F}_2 \neq 0$. According to [28] the weak saddle is of the order two. As $\tilde{M} \neq 0$ by Lemmas 3.1 and 3.5 (the statement (v)) we arrive at the following configurations:

- $s^{(2)}, f, \overline{sn}_{(2)}; N^\infty, \odot, \odot$: Example \Rightarrow ((3.3) : $c = -4/25, e = 1, h = -172/625, m = -4/5, u = 36/25$) (if $\eta < 0, \theta < 0$);
- $s^{(2)}, f, \overline{sn}_{(2)}; N^f, \odot, \odot$: Example \Rightarrow ((3.3) : $c = -2, e = 1, h = 1/2, m = -3/2, u = 1$) (if $\eta < 0, \theta > 0$);
- $s^{(2)}, f, \overline{sn}_{(2)}; N^d, \odot, \odot$: Example \Rightarrow ((3.3) : $c = -1/5, e = 1, h = (13 - 15\xi)/50, m = -(1 + 5\xi)/10, u = \xi$) (where $\xi = \theta^{-1}(0) \approx 1.568605$) (if $\eta < 0, \theta = 0$);
- $s^{(2)}, f, \overline{sn}_{(2)}; S, N^\infty, N^\infty$: Example \Rightarrow ((3.3) : $c = 1/20, e = 1, h = -3/16, m = -3/40, u = 1/5$) (if $\eta > 0, \theta < 0, \theta_1 < 0$);
- $s^{(2)}, f, \overline{sn}_{(2)}; S, N^f, N^f$: Example \Rightarrow ((3.3) : $c = -9/8, e = 1, h = 1/2, m = -5/8, u = 1/8$) (if $\eta > 0, \theta < 0, \theta_1 > 0$);
- $s^{(2)}, f, \overline{sn}_{(2)}; S, N^\infty, N^f$: Example \Rightarrow ((3.3) : $c = 1/10, e = 1, h = -2/5, m = -3/20, u = 2/5$) (if $\eta > 0, \theta > 0$);
- $s^{(2)}, f, \overline{sn}_{(2)}; S, N^\infty, N^d$: Example \Rightarrow ((3.3) : $c = 1/20, e = 1, h = -(31 + 220\xi)/400, m = (1 - 20\xi)/40, u = \xi$) (where $\xi = \theta^{-1}(0) \approx 0.193463$) (if $\eta > 0, \theta = 0, \theta_1 < 0$);
- $s^{(2)}, f, \overline{sn}_{(2)}; S, N^f, N^d$: Example \Rightarrow ((3.3) : $c = (1 + 8\xi)/4, e = 1, h = -3(1 + 4\xi)/8, m = \xi, u = 1/4$) (where $\xi = -(3 + \sqrt{5})/8$) (if $\eta > 0, \theta = 0, \theta_1 > 0$);

• $s^{(2)}, f, \overline{sn}_{(2)}; \binom{0}{2} SN, N^f$: Example \Rightarrow ((3.3) : $c = -6/5, e = 1, h = (35\zeta + 18)/50, m = -(5\zeta + 6)/10, u = \zeta$) (where $\zeta = \eta^{-1}(0) \approx 0.07381883$) (if $\eta = 0$).

β_2) The subcase $\mathcal{F}_2 = 0$. As it was shown earlier (see page 44, p. β_2) in this case we get $c = -u/6$ and then we calculate:

$$\tau_4 = u^2(u - 6)(25u - 42)/324, \quad \theta_2 = -u^2(u - 6)(22u - 27)/864.$$

So considering (3.11) we observe that the condition $\tau_4 < 0$ implies $42/25 < u < 6$ and then $\eta < 0$ and $\theta_2 \mathcal{F}_3 \mathcal{F}_4 \neq 0$. Hence we could not have a center in this case. Considering Lemma 3.1 we arrive at the following three configurations of singularities:

• $s^{(3)}, f, \overline{sn}_{(2)}; N^\infty, \odot, \odot$: Example \Rightarrow ((3.3) : $c = -17/60, e = 1, h = -17/720, m = -119/120, u = 17/10$) (if $\theta < 0$);

• $s^{(3)}, f, \overline{sn}_{(2)}; N^f, \odot, \odot$: Example \Rightarrow ((3.3) : $c = -1/3, e = 1, h = 1/18, m = -7/6, u = 2$) (if $\theta > 0$);

• $s^{(3)}, f, \overline{sn}_{(2)}; N^d, \odot, \odot$: Example \Rightarrow ((3.3) : $c = -\zeta/6, e = 1, h = \zeta(5\zeta - 9)/36, m = -7\zeta/12, u = \zeta$) (where $\zeta = 27(17 - 3\sqrt{21})/50$) (if $\theta = 0$).

b) The subcase $\mathcal{T}_3 = 0$. In this case we have $\rho_3 = \rho_4 = 0$ and hence both singularities are weak. Considering Remark 3.7 we have $\mathcal{F}_1 \neq 0$ and $\tilde{M} \neq 0$, i.e. both singularities have order one and at infinity there could not be a triple singularity. Moreover, we claim, that in this case the condition $\theta = \theta_1 = 0$ could not be satisfied. Indeed, suppose the contrary, that $\theta = \theta_1 = 0$. As it was shown in the proof of the statement (iii) of Lemma 3.5 (see page 28) in this case for systems (3.3) the conditions $m = -c$ and $h = -eu$ must hold. However this implies

$$\rho_3 = eu - 3c, \quad \rho_4 = c - eu, \quad \mu_0 = 4u(c^2 - e^2u)^2$$

and evidently the condition $\rho_3 = \rho_4 = 0$ yields $\mu_0 = 0$ and this contradiction proves our claim.

b_1) The subcase $\eta < 0$. Then systems (3.3) possess one real and two complex infinite singular points and according to Lemmas 3.1 and 3.5 (the statement (iii)) there can only be 3 distinct configurations at infinity:

• $s^{(1)}, f^{(1)}, \overline{sn}_{(2)}; N^\infty, \odot, \odot$: Example \Rightarrow ((3.3) : $c = 2, e = 1, h = 1/4, m = -1/4, u = 5/2$) (if $\theta < 0$);

• $s^{(1)}, f^{(1)}, \overline{sn}_{(2)}; N^f, \odot, \odot$: Example \Rightarrow ((3.3) : $c = 1, e = 0, h = -1/2, m = 1/2, u = 1$) (if $\theta > 0$);

• $s^{(1)}, f^{(1)}, \overline{sn}_{(2)}; N^d, \odot, \odot$: Example \Rightarrow ((3.3) : $c = 2, e = 1, h = \zeta/2 - 1, m = 1 - \zeta/2, u = \zeta$) (where $\zeta = \theta^{-1}(0) \approx 2.50977025$) (if $\theta = 0$).

b_2) The subcase $\eta > 0$. In this case systems (3.3) possess three real infinite singular points. Taking into consideration the conditions $\mu > 0, \theta^2 + \theta_1^2 \neq 0$ and Lemmas 3.1 and 3.5 (the statement (iii)) we could have at infinity only 5 distinct configurations. The corresponding examples are:

• $s^{(1)}, f^{(1)}, \overline{sn}_{(2)}; S, N^\infty, N^\infty$: Example \Rightarrow ((3.3) : $c = 619/5, e = 1, h = 1001/10, m = -1001/10, u = 324$) (if $\theta < 0, \theta_1 < 0$);

• $s^{(1)}, f^{(1)}, \overline{sn}_{(2)}; S, N^f, N^f$: Example \Rightarrow ((3.3) : $c = 1, e = 0, h = -1/2, m = 1/2, u = 1/10$) (if $\theta < 0, \theta_1 > 0$);

• $s^{(1)}, f^{(1)}, \overline{sn}_{(2)}; S, N^\infty, N^f$: Example \Rightarrow ((3.3) : $c = 1, e = 0, h = -1/2, m = 1/2, u = 3/25$) (if $\theta > 0$);

• $s^{(1)}, f^{(1)}, \overline{sn}_{(2)}; S, N^\infty, N^d$: Example \Rightarrow ((3.3) : $c = 6804/55, e = 1, h = 5508/55, m = -5508/55, u = 324$) (if $\theta = 0, \theta_1 < 0$);

• $s^{(1)}, f^{(1)}, \overline{sn}_{(2)}; S, N^f, N^d$: Example \Rightarrow ((3.3) : $c = 1, e = 0, h = -1/2, m = 1/2, u = 1/9$) (if $\theta = 0, \theta_1 > 0$).

b₃) The subcase $\eta = 0$. Since by Lemma 3.8 we have $\tilde{M} \neq 0$, in this case systems (3.3) possess at infinity one double and one simple real singular points. So by Lemmas 3.1 and 3.5 (the statement (iii)) we have the following 3 configurations :

• $s^{(1)}, f^{(1)}, \overline{sn}_{(2)}; \binom{0}{2} SN, N^\infty$: Example \Rightarrow ((3.3) : $c = \xi, e = 1, h = (324 - \xi)/2, m = (\xi - 324)/2, u = 324$) (where $\xi = \eta^{-1}(0) \approx 123.8421627$) (if $\theta < 0$);

• $s^{(1)}, f^{(1)}, \overline{sn}_{(2)}; \binom{0}{2} SN, N^f$: Example \Rightarrow ((3.3) : $c = 1, e = 0, h = -1/2, m = 1/2, u = 1/8$) (if $\theta > 0$);

• $s^{(1)}, f^{(1)}, \overline{sn}_{(2)}; \binom{0}{2} SN, N^d$: Example \Rightarrow ((3.3) : $c = \xi, e = 1, h = (\chi - \xi)/2, m = (\xi - \chi)/2, u = \chi$) (where $(\xi, \chi) = (\eta^{-1}(0), \theta^{-1}(0)) = (123 + 55\sqrt{5})/2, 161 + 72\sqrt{5}$) (if $\theta = 0$).

The possibility $W_4 > 0$. According to [8, Table 1, line 75] besides the semi-elemental saddle-node we have a saddle and a node and this node is generic (due to $W_4 \neq 0$, i.e. $\tau_3\tau_4 \neq 0$).

1) The case $\mathcal{T}_4 \neq 0$. Then $\rho_3\rho_4 \neq 0$ and the saddle is strong.

a) The subcase $\eta < 0$. According to Lemma 3.1 we obtain 4 distinct configurations:

• $s, n, \overline{sn}_{(2)}; N^\infty, \odot, \odot$: Example \Rightarrow ((3.3) : $c = -3, e = 0, h = 1, m = 1, u = 1$) (if $\theta < 0$);

• $s, n, \overline{sn}_{(2)}; N^f, \odot, \odot$: Example \Rightarrow ((3.3) : $c = 4, e = 0, h = 2, m = 1, u = 1$) (if $\theta > 0$);

• $s, n, \overline{sn}_{(2)}; N^d, \odot, \odot$: Example \Rightarrow ((3.3) : $c = 3, e = 1, h = 4, m = 1, u = 4$) (if $\theta = 0, \theta_2 \neq 0$);

• $s, n, \overline{sn}_{(2)}; N^*, \odot, \odot$: Example \Rightarrow ((3.3) : $c = -2, e = 1, h = 0, m = 1, u = 1$) (if $\theta = 0, \theta_2 = 0$).

b) The subcase $\eta > 0$.

Taking into consideration Lemmas 3.1 and 3.5 (the statement (iii)) we could have at infinity only 9 distinct configurations. The corresponding examples are:

• $s, n, \overline{sn}_{(2)}; S, N^\infty, N^\infty$: Example \Rightarrow ((3.3) : $c = -3/2, e = 0, h = 1/3, m = 1, u = 1$) (if $\theta < 0, \theta_1 < 0$);

• $s, n, \overline{sn}_{(2)}; S, N^f, N^f$: Example \Rightarrow ((3.3) : $c = -1/2, e = 0, h = 1/3, m = 1, u = 1$) (if $\theta < 0, \theta_1 > 0$);

• $s, n, \overline{sn}_{(2)}; S, N^\infty, N^f$: Example \Rightarrow ((3.3) : $c = -1/2, e = 0, h = 2, m = 1, u = 1$) (if $\theta > 0$);

• $s, n, \overline{sn}_{(2)}; S, N^\infty, N^d$: Example \Rightarrow ((3.3) : $c = -3/2, e = 0, h = 1/2, m = 1, u = 1$) (if $\theta = 0, \theta_1 < 0, \theta_2 \neq 0$);

• $s, n, \overline{sn}_{(2)}; S, N^\infty, N^*$: Example \Rightarrow ((3.3) : $c = 4, e = 1, h = -3, m = -2, u = 1$) (if $\theta = 0, \theta_1 < 0, \theta_2 = 0$);

• $s, n, \overline{sn}_{(2)}; S, N^f, N^d$: Example \Rightarrow ((3.3) : $c = -1/2, e = 0, h = 1/2, m = 1, u = 1$) (if $\theta = 0, \theta_1 > 0, \theta_2 \neq 0$);

• $s, n, \overline{sn}_{(2)}; S, N^f, N^*$: Example \Rightarrow ((3.3) : $c = -2, e = 1, h = 3, m = -2, u = 1$) (if $\theta = 0, \theta_1 > 0, \theta_2 = 0$);

• $s, n, \overline{sn}_{(2)}; S, N^d, N^d$: Example \Rightarrow ((3.3) : $c = 0, e = -1/2, h = 1, m = 0, u = 2$) (if $\theta = \theta_1 = 0, \theta_3 \neq 0$);

• $s, n, \overline{sn}_{(2)}; S, N^d, N^*$: Example \Rightarrow ((3.3) : $c = 2, e = 1, h = -1, m = -2, u = 1$) (if $\theta = \theta_1 = 0, \theta_3 = 0$).

c) *The subcase $\eta = 0$* In this case systems (3.3) possess at infinity either one double and one simple real singular points (if $\tilde{M} \neq 0$) or one triple real singularity (if $\tilde{M} = 0$). By Lemma 3.1 we could have at infinity exactly 5 distinct configurations. So we have the following 4 configurations:

- $s, n, \overline{sn}_{(2)}; \binom{0}{2}SN, N^\infty$: Example \Rightarrow ((3.3) : $c = 1, e = 0, h = 1/2, m = -3/8, u = 1$) (if $\theta < 0$);

- $s, n, \overline{sn}_{(2)}; \binom{0}{2}SN, N^f$: Example \Rightarrow ((3.3) : $c = 1, e = 0, h = 2, m = 3/2, u = 1$) (if $\theta > 0$);

- $s, n, \overline{sn}_{(2)}; \binom{0}{2}SN, N^d$: Example \Rightarrow ((3.3) : $c = 1, e = 1, h = -2(7 + 5\sqrt{2}), m = 0, u = 17 + 12\sqrt{2}$) (if $\theta = 0, \theta_2 \neq 0$);

- $s, n, \overline{sn}_{(2)}; \binom{0}{2}SN, N^*$: Example \Rightarrow ((3.3) : $c = -4, e = 1, h = 7/2, m = -1/2, u = 1$) (if $\theta = 0, \theta_2 = 0$)

if $\tilde{M} \neq 0$ and one configuration

- $s, n, \overline{sn}_{(2)}; \binom{0}{3}N$: Example \Rightarrow ((3.3) : $c = 1, e = 1, h = 40/27, m = 3/2, u = 64/27$)

if $\tilde{M} = 0$.

2) *The case $\mathcal{T}_4 = 0$* . By (3.5) we get $\rho_3\rho_4 = 0$ and hence the saddle is weak. We consider two subcases: $\mathcal{F}_1 \neq 0$ and $\mathcal{F}_1 = 0$.

a) *The subcase $\mathcal{F}_1 \neq 0$* . Then by [28] the weak saddle has order one.

a₁) *The possibility $\eta < 0$* . Considering Lemmas 3.1 and 3.5 (the statement (iii)) there can only be 3 distinct configurations at infinity:

- $s^{(1)}, n, \overline{sn}_{(2)}; N^\infty, \odot, \odot$: Example \Rightarrow ((3.3) : $c = 1, e = 1, h = -2, m = -1, u = 3$) (if $\theta < 0$);

- $s^{(1)}, n, \overline{sn}_{(2)}; N^f, \odot, \odot$: Example \Rightarrow ((3.3) : $c = 2, e = 0, h = 2, m = 1, u = 1$) (if $\theta > 0$);

- $s^{(1)}, n, \overline{sn}_{(2)}; N^d, \odot, \odot$: Example \Rightarrow ((3.3) : $c = -3, e = 1, h = 7/2, m = -3/4, u = 4$) (if $\theta = 0$).

a₂) *The possibility $\eta > 0$* . Since for these systems the condition $\mu_0 > 0$ holds, taking into consideration Lemmas 3.1 and 3.5 (the statement (iii)) we could have at infinity only 6 distinct configurations. The corresponding examples are:

- $s^{(1)}, n, \overline{sn}_{(2)}; S, N^\infty, N^\infty$: Example \Rightarrow ((3.3) : $c = 0, e = 1, h = -1/2, m = -3/4, u = 3/2$) (if $\theta < 0, \theta_1 < 0$);

- $s^{(1)}, n, \overline{sn}_{(2)}; S, N^f, N^f$: Example \Rightarrow ((3.3) : $c = 1, e = 0, h = 2, m = 1/2, u = 1$) (if $\theta < 0, \theta_1 > 0$);

- $s^{(1)}, n, \overline{sn}_{(2)}; S, N^\infty, N^f$: Example \Rightarrow ((3.3) : $c = 1, e = 0, h = 2, m = 1/2, u = 9/5$) (if $\theta > 0$);

- $s^{(1)}, n, \overline{sn}_{(2)}; S, N^\infty, N^d$: Example \Rightarrow ((3.3) : $c = 2/3, e = 1, h = -2, m = -5/3, u = 4$) (if $\theta = 0, \theta_1 < 0$);

- $s^{(1)}, n, \overline{sn}_{(2)}; S, N^f, N^d$: Example \Rightarrow ((3.3) : $c = 0, e = -1, h = -2, m = -3, u = 4$) (if $\theta = 0, \theta_1 > 0$);

- $s^{(1)}, n, \overline{sn}_{(2)}; S, N^d, N^d$: Example \Rightarrow ((3.3) : $c = 2/3, e = 1, h = -2, m = -2/3, u = 2$) (if $\theta = 0, \theta_1 = 0$).

a₃) *The possibility $\eta = 0$* . In this case systems (3.3) possess at infinity either one double and one simple real singular points (if $\tilde{M} \neq 0$) or one triple real singularity (if $\tilde{M} = 0$). So by Lemmas 3.1 and Lemma 3.5 (the statement (iii)) we have the following 3 configurations:

- $s^{(1)}, n, \overline{sn}_{(2)}; \binom{0}{2}SN, N^\infty$: Example \Rightarrow ((3.3) : $c = 1, e = 2, h = -3, m = -3/2, u = 2$) (if $\theta < 0$);

• $s^{(1),n,\overline{sn}}_{(2)}; \binom{0}{2} SN, N^f$: Example \Rightarrow ((3.3) : $c = 1, e = 0, h = 2, m = 1/2, u = 2$) (if $\theta > 0$);

• $s^{(1),n,\overline{sn}}_{(2)}; \binom{0}{2} SN, N^d$: Example \Rightarrow ((3.3) : $c = \xi^2 - 2, e = 1, h = \xi(3 - \xi - \xi^2), m = -1, u = \xi^2$) (where $\xi = \eta^{-1}(0) \approx 1.3816417$) (if $\theta = 0$)
if $\tilde{M} \neq 0$ and one configuration

• $s^{(1),n,\overline{sn}}_{(2)}; \binom{0}{3} N$: Example \Rightarrow ((3.3) : $c = 17 - 3\sqrt{33}, e = 1, h = (155 - 27\sqrt{33})/2, m = -1, u = 19 - 3\sqrt{33}$)
if $\tilde{M} = 0$.

b) The subcase $\mathcal{F}_1 = 0$. In this case according to [28] the weak saddle is of order at least two. We claim that for $\mathcal{F}_1 = 0$ we could not have $\theta = \theta_1 = 0$. Indeed, suppose the contrary. As it was shown in the proof of the statement (iii) of Lemma 3.5 (see page 28) in this case for systems (3.3) the conditions $m = -c$ and $h = -eu$ must hold. Then we have $\rho_3 = eu - 3c = 0$ (i.e. $c = eu/3$) and this implies

$$\mathcal{F}_1 = 16e^4u^4(u - 9)/81, \quad \mu_0 = 4e^4u^3(u - 9u)^2/81$$

and evidently the condition $\mu_0 \neq 0$ gives $\mathcal{F}_1 \neq 0$. The contradiction we have obtained proves our claim.

b₁) The possibility $\mathcal{F}_2 \neq 0$. Then we have a weak saddle of order two.

α) The case $\eta < 0$. According to Lemmas 3.1 and 3.5 (the statement (iii)) there can only be 3 distinct configurations at infinity:

• $s^{(2),n,\overline{sn}}_{(2)}; N^\infty, \odot, \odot$: Example \Rightarrow ((3.3) : $c = -1/3, e = 1, h = 1/6, m = -5/6, u = 4/3$) (if $\theta < 0$);

• $s^{(2),n,\overline{sn}}_{(2)}; N^f, \odot, \odot$: Example \Rightarrow ((3.3) : $c = -3, e = 1, h = -13/4, m = -7/4, u = 1/2$) (if $\theta > 0$);

• $s^{(2),n,\overline{sn}}_{(2)}; N^d, \odot, \odot$: Example \Rightarrow ((3.3) : $c = (841 + 800\xi)/400, e = 1, h = -29(1421 + 1200\xi)/8000, m = \xi, u = 841/400$) (where $\xi = (-2253 + \sqrt{23281})/1600$) (if $\theta = 0$).

β) The case $\eta > 0$.

Thus as for these systems the condition $\mu_0 > 0$ holds, taking into consideration Lemmas 3.1 and 3.5 (the statement (iii)) we could have at infinity only 5 distinct configurations. The corresponding examples are:

• $s^{(2),n,\overline{sn}}_{(2)}; S, N^\infty, N^\infty$: Example \Rightarrow ((3.3) : $c = -2/3, e = 1, h = 25/27, m = -13/9, u = 20/9$) (if $\theta < 0, \theta_1 < 0$);

• $s^{(2),n,\overline{sn}}_{(2)}; S, N^f, N^f$: Example \Rightarrow ((3.3) : $c = 1, e = 1, h = -4, m = 0, u = 1$) (if $\theta < 0, \theta_1 > 0$);

• $s^{(2),n,\overline{sn}}_{(2)}; S, N^\infty, N^f$: Example \Rightarrow ((3.3) : $c = 1/2, e = 1, h = -4, m = -5/4, u = 3$) (if $\theta > 0$);

• $s^{(2),n,\overline{sn}}_{(2)}; S, N^\infty, N^d$: Example \Rightarrow ((3.3) : $c = -3/5, e = 1, h = (27 + 5\xi)/50, m = -(3 + 5\xi)/10, u = \xi$) (where $\xi = \theta^{-1}(0) \approx 2.1793598$) (if $\theta = 0, \theta_1 < 0$);

• $s^{(2),n,\overline{sn}}_{(2)}; S, N^f, N^d$: Example \Rightarrow ((3.3) : $c = -2, e = 1, h = (3\xi - 2)/2, m = -(2 + \xi)/2, u = \xi$) (where $\xi = \theta^{-1}(0) \approx 0.07264$) (if $\theta = 0, \theta_1 > 0$)

γ) The case $\eta = 0$ In this case systems (3.3) possess at infinity either one double and one simple real singular points (if $\tilde{M} \neq 0$) or one triple real singularity (if $\tilde{M} = 0$). So by Lemma 3.1 and Lemma 3.5 (the statement (iii)) we have the following 3 configurations:

• $s^{(2),n,\overline{sn}}_{(2)}; \binom{0}{2} SN, N^\infty$: Example \Rightarrow ((3.3) : $c = \xi, e = 1, h = -(43 + 146\xi + 40\xi^2)/40, m = (20\xi - 43)/40, u = 43/20$) (where $\xi = \eta^{-1}(0) \approx -0.5715053$) (if $\theta < 0$);

• $s^{(2)}, n, \overline{sn}_{(2)}; \binom{0}{2} SN, N^f$: Example \Rightarrow ((3.3) : $c = -2(5 + \sqrt{13})/3, e = 1, h = -(56 + 19\sqrt{13})/9, m = -(8 + \sqrt{13})/3, u = 2$) (if $\theta > 0$);

• $s^{(2)}, n, \overline{sn}_{(2)}; \binom{0}{2} SN, N^d$: Example \Rightarrow ((3.3) : $c = \xi, e = 1, h = -(2\xi^2 + 3\xi + 2\xi\chi + \chi)/2, m = (\chi - \xi)/2, u = \chi$) (where $(\xi, \chi) = (\eta^{-1}(0), \theta^{-1}(0)) \approx (-0.574581, 2.156464)$) (if $\theta = 0$)

if $\tilde{M} \neq 0$ and one configuration

• $s^{(2)}, n, \overline{sn}_{(2)}; \binom{0}{3} N$: Example \Rightarrow ((3.3) : $c = -1/2, e = 1, h = 1/2, m = -5/4, u = 2$)

if $\tilde{M} = 0$.

b₂) The possibility $\mathcal{F}_2 = 0$. Then by [28] we have either a weak saddle of order three or an integrable saddle.

As it was shown earlier (see page 44, p. β_2) in this case we get $c = -u/6$ and then we calculate:

$$\tau_4 = u^2(u - 6)(25u - 42)/324, \quad \mu_0 = u^3(u - 6)^2/144.$$

So considering (3.11) we observe that the conditions $\tau_3 > 0$ and $\tau_4 > 0$ imply $0 < u < 42/25$ and then $\eta < 0, \theta < 0$ and $\mathcal{F}_3\mathcal{F}_4 \neq 0$. Hence we could not have an integrable saddle and considering Lemma 3.1 in this case we get a single configuration of singularities:

• $s^{(3)}, n, \overline{sn}_{(2)}; N^\infty, \odot, \odot$: Example \Rightarrow ((3.3) : $c = -1/6, e = 1, h = -1/9, m = -7/12, u = 1$).

The possibility $W_4 = 0$. Since $E_1 \neq 0$ (i.e. $\rho_1 \neq 0$) by (3.5) we obtain $\tau_3\tau_4 = 0$ and therefore at least one elemental singular point is a node with coinciding eigenvalues and we may assume that such a singular point is $M_3(1, 0)$ (i.e. $\tau_3 = 0$). On the other hand considering [8] we conclude that besides this node we have a semi-elemental saddle-node $M_{1,2}(0, 0)$ and a saddle $M_4(0, 1)$.

1) The case $U_3 \neq 0$. Then the node $M_3(1, 0)$ is a one-direction node.

a) The subcase $\mathcal{T}_4 \neq 0$. We obtain $\rho_3\rho_4 \neq 0$ and the saddle is strong.

a₁) The possibility $\eta < 0$. According to Lemmas 3.1 and 3.5 (the statement (iii)) there can only be 3 distinct configurations at infinity:

• $s, n^d, \overline{sn}_{(2)}; N^\infty, \odot, \odot$: Example \Rightarrow ((3.3) : $c = 2, e = 1, h = 1/8, m = 0, u = 1$) (if $\theta < 0$);

• $s, n^d, \overline{sn}_{(2)}; N^f, \odot, \odot$: Example \Rightarrow ((3.3) : $c = 0, e = 1, h = 1/8, m = 0, u = 1$) (if $\theta > 0$);

• $s, n^d, \overline{sn}_{(2)}; N^d, \odot, \odot$: Example \Rightarrow ((3.3) : $c = -11/4, e = 1, h = 9/8, m = 0, u = 1/4$) (if $\theta = 0$).

a₂) The possibility $\eta > 0$. Since for these systems the condition $\mu_0 > 0$ holds, taking into consideration Lemmas 3.1 and 3.5 (the statement (iii)) we could have at infinity only 6 distinct configurations. The corresponding examples are:

• $s, n^d, \overline{sn}_{(2)}; S, N^\infty, N^\infty$: Example \Rightarrow ((3.3) : $c = -4, e = -1, h = 15/8, m = 3, u = 1$) (if $\theta < 0, \theta_1 < 0$);

• $s, n^d, \overline{sn}_{(2)}; S, N^f, N^f$: Example \Rightarrow ((3.3) : $c = 0, e = -1, h = -1/2, m = 2, u = 2$) (if $\theta < 0, \theta_1 > 0$);

• $s, n^d, \overline{sn}_{(2)}; S, N^\infty, N^f$: Example \Rightarrow ((3.3) : $c = 0, e = -1, h = -9/8, m = 2, u = 1$) (if $\theta > 0$);

• $s, n^d, \overline{sn}_{(2)}; S, N^\infty, N^d$: Example \Rightarrow ((3.3) : $c = -6, e = -1, h = 10, m = 3, u = 4$) (if $\theta = 0, \theta_1 < 0$);

• $s, n^d, \overline{sn}_{(2)}; S, N^f, N^d$: Example \Rightarrow ((3.3) : $c = 0, e = 1, h = 8, m = -6, u = 4$) (if $\theta = 0, \theta_1 > 0$);

• $s, n^d, \overline{sn}_{(2)}; S, N^d, N^d$: Example \Rightarrow ((3.3) : $c = 10, e = 1, h = -2, m = -10, u = 2$) (if $\theta = 0, \theta_1 = 0$).

a₃) The possibility $\eta = 0$. In this case systems (3.3) possess at infinity either one double and one simple real singular points (if $\tilde{M} \neq 0$) or one triple real singularity (if $\tilde{M} = 0$). So by Lemmas 3.1 and Lemma 3.5 (the statement (iii)) we have the following 3 configurations:

• $s, n^d, \overline{sn}_{(2)}; \binom{0}{2} SN, N^\infty$: Example \Rightarrow ((3.3) : $c = 1, e = 0, h = 1/2, m = -1/2, u = 2$) (if $\theta < 0$);

• $s, n^d, \overline{sn}_{(2)}; \binom{0}{2} SN, N^f$: Example \Rightarrow ((3.3) : $c = 1, e = 0, h = 1, m = -1/2, u = 1$) (if $\theta > 0$);

• $s, n^d, \overline{sn}_{(2)}; \binom{0}{2} SN, N^d$: Example \Rightarrow ((3.3) : $c = 1, e = 0, h = 1/2, m = -1/2, u = 1$) (if $\theta = 0$)

if $\tilde{M} \neq 0$ and one configuration

• $s, n^d, \overline{sn}_{(2)}; \binom{0}{3} N$: Example \Rightarrow ((3.3) : $c = 1, e = 0, h = 0, m = -1/2, u = 1$)

if $\tilde{M} = 0$.

b) The subcase $\mathcal{T}_4 = 0$. We obtain $\rho_3\rho_4 = 0$ (then $\rho_4 = 0$ due to $\tau_3 = 0$) and the saddle is weak.

b₁) The possibility $\mathcal{F}_1 \neq 0$. In his case we have a weak saddle of order one.

α) The case $\eta < 0$. According to Lemmas 3.1 and 3.5 (the statement (iii)) there can be 4 distinct configurations at infinity:

• $s^{(1)}, n^d, \overline{sn}_{(2)}; N^\infty, \odot, \odot$: Example \Rightarrow ((3.3) : $c = 4, e = 1, h = 2, m = 0, u = 8$) (if $\theta < 0$);

• $s^{(1)}, n^d, \overline{sn}_{(2)}; N^f, \odot, \odot$: Example \Rightarrow ((3.3) : $c = -1, e = 1, h = 2, m = 0, u = 3$) (if $\theta > 0$);

• $s^{(1)}, n^d, \overline{sn}_{(2)}; N^d, \odot, \odot$: Example \Rightarrow ((3.3) : $c = (\zeta^2 - 48)/32, e = 1, h = 2 + \zeta/4, m = -1, u = (\zeta^2 + 16\zeta + 80)/32$) (where $\zeta = \theta^{-1}(0) \approx -9.4251021$) (if $\theta = 0, \theta_2 \neq 0$);

• $s^{(1)}, n^d, \overline{sn}_{(2)}; N^*, \odot, \odot$: Example \Rightarrow ((3.3) : $c = -3, e = 1, h = 2, m = 0, u = 1$) (if $\theta = 0, \theta_2 = 0$).

β) The case $\eta > 0$. Since $\mu_0 > 0$, by Lemma 3.1 there are 10 possibilities. However according to Lemma 3.5 (the statements (iii)₂ and (v)) the at infinity we cannot have in this case the configurations S, N^d, N^d or S, N^*, N^* .

Thus at infinity we could only have 8 distinct configurations. The corresponding examples are:

• $s^{(1)}, n^d, \overline{sn}_{(2)}; S, N^\infty, N^\infty$: Example \Rightarrow ((3.3) : $c = 17/4, e = 1/4, h = -2, m = -2, u = 1$) (if $\theta < 0, \theta_1 < 0$);

• $s^{(1)}, n^d, \overline{sn}_{(2)}; S, N^f, N^f$: Example \Rightarrow ((3.3) : $c = -7/6, e = 1, h = 4, m = -3, u = 41/6$) (if $\theta < 0, \theta_1 > 0$);

• $s^{(1)}, n^d, \overline{sn}_{(2)}; S, N^\infty, N^f$: Example \Rightarrow ((3.3) : $c = -23/32, e = 1, h = 3/4, m = -1, u = 25/32$) (if $\theta > 0$);

• $s^{(1)}, n^d, \overline{sn}_{(2)}; S, N^\infty, N^d$: Example \Rightarrow ((3.3) : $c = (12 - \sqrt{287})/156, e = -12(14 + \sqrt{287})/13, h = (11 + \sqrt{287})/144, m = 1/12, u = 1/144$) (if $\theta = 0, \theta_1 < 0, \theta_2 \neq 0$);

• $s^{(1)}, n^d, \overline{sn}_{(2)}; S, N^\infty, N^*$: Example \Rightarrow ((3.3) : $c = 1, e = 5, h = -4, m = -2, u = 1$) (if $\theta = 0, \theta_1 < 0, \theta_2 = 0$);

• $s^{(1)}, n^d, \overline{sn}_{(2)}; S, N^f, N^d$: Example \Rightarrow ((3.3) : $c = (2 - \sqrt{7})/6, e = 2(4 - \sqrt{7})/3, h = (-1 + \sqrt{7})/4, m = -1/2, u = 1/4$) (if $\theta = 0, \theta_1 > 0, \theta_2 \neq 0$);

- $s^{(1)}, n^d, \overline{sn}_{(2)}; S, N^f, N^*$: Example \Rightarrow ((3.3) : $c = 1, e = 1, h = -2, m = 0, u = 1$) (if $\theta = 0, \theta_1 > 0, \theta_2 = 0$);
- $s^{(1)}, n^d, \overline{sn}_{(2)}; S, N^d, N^*$: Example \Rightarrow ((3.3) : $c = 1/3, e = 1, h = -1, m = -1/3, u = 1$) (if $\theta = \theta_1 = 0$).

γ) *The case $\eta = 0$* In this case systems (3.3) possess at infinity either one double and one simple real singular points (if $\tilde{M} \neq 0$) or one triple real singularity (if $\tilde{M} = 0$). Since by Lemma 3.5 (the statements (iii))

So by Lemmas 3.1 and Lemma 3.5 (the statement (iii)) we have the following 3 configurations:

- $s^{(1)}, n^d, \overline{sn}_{(2)}; \binom{0}{2}SN, N^\infty$: Example \Rightarrow ((3.3) : $c = 1 - 2\zeta, e = 1, h = \zeta, m = \zeta, u = 1$) (where $\zeta = \eta^{-1}(0) \approx -7.41375$) (if $\theta < 0$);
- $s^{(1)}, n^d, \overline{sn}_{(2)}; \binom{0}{2}SN, N^f$: Example \Rightarrow ((3.3) : $c = -2\zeta + 2\sqrt{1 + 2\zeta}, e = -1, h = -1 + \zeta - \sqrt{1 + 2\zeta}, m = \zeta, u = 2$) (where $\zeta = \eta^{-1}(0) \approx 1.42926$) (if $\theta > 0$);
- $s^{(1)}, n^d, \overline{sn}_{(2)}; \binom{0}{2}SN, N^d$: Example \Rightarrow ((3.3) : $c = \frac{3\zeta - \chi}{\chi - 1}, e = \frac{\zeta + 2\zeta\chi - \chi}{\chi^2(\chi - 1)}, h = \zeta, m = 1, u = \chi^2$) (where $(\zeta, \chi) = (\eta^{-1}(0), W_4^{-1}(0)) \approx (-2.58495, 36.90034)$) (if $\theta = 0$)

if $\tilde{M} \neq 0$ and one configuration

- $s^{(1)}, n^d, \overline{sn}_{(2)}; \binom{0}{3}N$: Example \Rightarrow ((3.3) : $c = 32/27, e = -1, h = -8/9, m = 20/27, u = 16/27$) (if $\tilde{M} = 0$).

b₂) *The possibility $\mathcal{F}_1 = 0$.* In this case we have a weak saddle of order at least two. We consider two cases: $\mathcal{F}_2 \neq 0$ and $\mathcal{F}_2 = 0$.

a) *The case $\mathcal{F}_2 \neq 0$.* Then the weak saddle has order two.

Assume that for systems (3.3) the conditions $\mu_0 E_1 \neq 0$ and $\mathcal{T}_4 = \mathcal{F}_1 = W_4 = 0$ are satisfied. As it was shown earlier (see page 43) the conditions $\mathcal{T}_4 = 0$ (we assume $\rho_3 = 0$) and $\mathcal{F}_1 = 0$ imply the relations (3.10). Therefore the condition $W_4 = 0$ (which in this case is equivalent to $\tau_4 = 0$) gives

$$\begin{aligned} E_1 &= -(1+c)^4 u^2 (c+u) (3c+u)^4 / 2, & \mathcal{F}_2 &= -c(1+c)^4 u^2 (c+u)^4 (3c+u)^2 (6c+u), \\ \mathcal{F}_3 &= -c(1+c)^4 u^2 (c+u)^4 (2c+u) (3c+u)^2, & & \\ \tau_4 &= 4c(1+c) [(c+u)^2 + c - u] \equiv 4c(1+c) \psi(c, u), & & \end{aligned} \quad (3.12)$$

and as $\mathcal{F}_2 \neq 0$ the condition $\tau_4 = 0$ implies $\psi(c, u) = 0$. Since $\text{Discriminant}[\psi, c] = 1 + 8u$ in order to have a real solution we set $1 + 8u = v^2$ (i.e. $u = (v^2 - 1)/8$) and then we obtain $\psi(c, v^2 - 1) = (3 + 8c - 4v + v^2)(3 + 8c + 4v + v^2)/64 = 0$. We may consider only the first factor because the second factor is obtained from the first one by replacing v by $-v$ and we arrive at the same result.

So $c = (4v - v^2 - 3)/8$ and we calculate

$$\begin{aligned} \mathcal{T}_4 = \mathcal{F}_1 = W_4 &= 0, & \mu_0 &= 2^{-13} (v-5)^4 (v^2-1)^3, \\ \mathcal{F}_2 &= -2^{-32} (v-5)^6 (v-3)(v-1)^{10} (1+v)^6 (5v-19), \\ \eta &= -2^{-13} (v-5)^2 (v-3)(v-1)^3 (1+v) (205 + 67v - 65v^2 + 9v^3), \\ \theta &= (v-5)^2 (v-3)(v-1)^3 (1+v) (11 + v - 5v^2 + v^3) / 256, \\ \theta_1 &= -(v-5)^2 (v-1)^3 (1+v) (38v - 361 + 166v^2 - 66v^3 + 7v^4) / 256, \\ \theta_2 &= 2^{-11} (v-5)^2 (v-3)(v-1)^2 (1+v) (v^2 - v - 4). \end{aligned} \quad (3.13)$$

As we have only one parameter v which satisfies $|v| > 1$ (due to $\mu_0 > 0$) we could only obtain the following configurations:

- $s^{(2)}, n^d, \overline{sn}_{(2)}; N^\infty, \odot, \odot$: Example \Rightarrow ((3.3) : $c = -3/8, e = 1, h = 3/16, m = -9/8, u = 15/8$) (if $\eta < 0, \theta < 0$);
- $s^{(2)}, n^d, \overline{sn}_{(2)}; N^f, \odot, \odot$: Example \Rightarrow ((3.3) : $c = -15/8, e = 1, h = -3/16, m = -9/8, u = 3/8$) (if $\eta < 0, \theta > 0$);
- $s^{(2)}, n^d, \overline{sn}_{(2)}; N^d, \odot, \odot$: Example \Rightarrow ((3.3) : $c = (3 - \xi)(\xi - 1)/8, e = 1, h = (\xi - 1)(\xi^2 - 2\xi - 7)/16, m = -(\xi - 1)^2/8, u = (\xi^2 - 1)/8$) (where $\xi = \theta^{-1}(0) \approx 4.10277$) (if $\eta < 0, \theta = 0$);
- $s^{(2)}, n^d, \overline{sn}_{(2)}; S, N^f, N^f$: Example \Rightarrow ((3.3) : $c = 1/8, e = 1, h = -7/16, m = -1/8, u = 3/8$) (if $\eta > 0, \theta < 0$);
- $s^{(2)}, n^d, \overline{sn}_{(2)}; S, N^\infty, N^f$: Example \Rightarrow ((3.3) : $c = 3/32, e = 1, h = -69/128, m = -9/32, u = 21/32$) (if $\eta > 0, \theta > 0$);
- $s^{(2)}, n^d, \overline{sn}_{(2)}; S, N^\infty, N^d$: Example \Rightarrow ((3.3) : $c = (3 - \xi)(\xi - 1)/8, e = 1, h = (\xi - 1)(\xi^2 - 2\xi - 7)/16, m = -(\xi - 1)^2/8, u = (\xi^2 - 1)/8$) (where $\xi = \theta^{-1}(0) \approx -1.24914$) (if $\eta > 0, \theta = 0$);
- $s^{(2)}, n^d, \overline{sn}_{(2)}; \binom{0}{2}SN, N^f$: Example \Rightarrow ((3.3) : $c = (3 - \xi)(\xi - 1)/8, e = 1, h = (\xi - 1)(\xi^2 - 2\xi - 7)/16, m = -(\xi - 1)^2/8, u = (\xi^2 - 1)/8$) (where $\xi = \eta^{-1}(0) \approx -1.25774$) (if $\eta = 0$).

β) The case $\mathcal{F}_2 = 0$. Since $E_1 \neq 0$ considering (3.12) we get $c(6c + u) = 0$ and then we obtain either $c = -u/6$ or $c = 0$.

In the first case we have

$$\mu_0 = (u - 6)^2 u^3 / 144, \quad \tau_4 = (u - 6) u^2 (25u - 42) / 324$$

and clearly due to $\mu_0 \neq 0$ the condition $\tau_4 = 0$ gives $u = 42/25$. So we obtain a system without parameters for which we detect $\eta < 0, \theta < 0$ and $\mathcal{F}_3 \mathcal{F}_4 \neq 0$.

Thus we get the unique configuration

- $s^{(3)}, n^d, \overline{sn}_{(2)}; N^\infty, \odot, \odot$: Example \Rightarrow ((3.3) : $c = -7/25, e = 1, h = -7/250, m = -49/50, u = 42/25$).

In the second case when $c = 0$ calculations yield

$$\mu_0 = u^3, \quad \theta = 8(u - 1)u^3, \quad \theta_2 = (u - 1)u^2/4, \quad \eta = W_4 = \mathcal{F}_3 = 0$$

and there will be 3 configurations at infinity, depending on the value of the invariant polynomial θ . On the other hand on the phase plane besides a one-direction node we have an integrable saddle (see [28, Main Theorem, the statement (b)]). Thus we arrive at the following configurations

- $s, n^d, \overline{sn}_{(2)}; \binom{0}{2}SN, N^\infty$: Example \Rightarrow ((3.3) : $c = 0, e = 1, h = -1/4, m = -1/4, u = 1/2$) (if $\theta < 0$);
- $s, n^d, \overline{sn}_{(2)}; \binom{0}{2}SN, N^f$: Example \Rightarrow ((3.3) : $c = 0, e = 1, h = -1, m = -1, u = 2$) (if $\theta > 0$);
- $s, n^d, \overline{sn}_{(2)}; \binom{0}{2}SN, N^*$: Example \Rightarrow ((3.3) : $c = 0, e = 1, h = -1/2, m = -1/2, u = 1$) (if $\theta = 0$).

2) The case $U_3 = 0$. Then the node $M_3(1, 0)$ is a star node. Considering the corresponding matrix from (3.4) we obtain $e = 0, h = -cu/2$ and $m = -c/2$ and $c \neq 0$, otherwise we get degenerate systems. So we may assume $c = 1$ (due to time rescaling) and we arrive at the family of systems

$$\dot{x} = x + uy - x^2 - uxy - uy^2, \quad \dot{y} = -xy, \quad (3.14)$$

for which we calculate

$$\begin{aligned} \eta = \mathcal{F}_1 = \mathcal{F}_4 = \theta_2 = 0, \quad \mu_0 = u, \quad \tilde{M} = -8u^2y^2 \\ \mathcal{T}_4 = 2u(u-1), \quad \theta = 8u(u-1), \quad \mathcal{F}_2 = u^2(u-1)(9+2u)/2, \end{aligned}$$

and therefore the conditions $\mathcal{T}_4 = 0$ and $\theta = 0$ (respectively $\mu = 0$ and $\tilde{M} = 0$) are equivalent. Moreover, the condition $\theta = 0$ implies $\mathcal{F}_2 = 0$.

Thus considering these implications, by Lemma 3.1 we could only have the following three configurations:

- $s, n^*, \overline{s\bar{n}}_{(2)}; \binom{0}{2}SN, N^\infty$: Example \Rightarrow ((3.14): $u = 1/2$ (if $\theta < 0$));
- $s, n^*, \overline{s\bar{n}}_{(2)}; \binom{0}{2}SN, N^f$: Example \Rightarrow ((3.14): $u = 2$ (if $\theta > 0$));
- $s, n^*, \overline{s\bar{n}}_{(2)}; \binom{0}{2}SN, N^*$: Example \Rightarrow ((3.14): $u = 1$ (if $\theta = 0$)).

The subcase $E_1 = 0$ In this case $\rho_1 = 0$ and besides the two elemental singularities we have a cusp. Moreover, since $\mu_0 > 0$ from (3.5) it follows $\Delta_3\Delta_4 < 0$, i.e. the two elemental singularities are a saddle and an anti-saddle. The condition $E_1 = 0$ gives $c = -eu$ and then $e \neq 0$, otherwise we get degenerate systems. So systems (3.3) become

$$\dot{x} = -ux - u^2y + ux^2 + 2hxy + u^2y^2, \quad \dot{y} = x + uy - x^2 + 2mxy - uy^2, \quad (3.15)$$

for which calculations yield

$$\begin{aligned} \mu_0 = 4u(h+mu)^2, \quad \mathcal{T}_4 = \mathcal{T}_3 = 0, \quad \mathcal{T}_2 = \mu_0\rho_3\rho_4, \quad \mathcal{T}_1 = \mu_0(\rho_3 + \rho_4), \\ W_4 = W_3 = 0, \quad W_2 = \mu_0^2\tau_3\tau_4, \quad W_1 = \mu_0^2(\tau_3 + \tau_4), \\ \theta = 64(h+mu)[(h+u)^2 - u(m-u)^2], \\ \eta = -4(\mathcal{N}_2^2 - \mathcal{N}_1\mathcal{N}_3)/3, \quad \tilde{M} = 8(\mathcal{N}_1x^2 - 2\mathcal{N}_2xy - \mathcal{N}_3y^2), \end{aligned} \quad (3.16)$$

where

$$\begin{aligned} \rho_3 = 2(m+u), \quad \rho_4 = 2(h-u), \quad \tau_3 = 4(m^2+u^2) - 8h, \quad \tau_4 = 4(h^2+u^2) + 8mu^2, \\ \mathcal{N}_1 = (2m-u)^2 - 6h - 3u, \quad \mathcal{N}_2 = 2hm - hu + mu + 4u^2, \quad \mathcal{N}_3 = (2h+u)^2 + 6mu^2 - 3u^3. \end{aligned}$$

Lemma 3.9. *if for a system (3.15) the condition $\mu_0 > 0$ holds then the condition $W_2 \leq 0$ implies $\theta > 0$.*

Proof. Assume that the condition $W_2 \leq 0$ holds. This implies $\tau_3\tau_4 \leq 0$ and we may assume $\tau_3 \leq 0$, i.e. the singular point $M_3(1,0)$ is either a focus or a node, and then for the saddle we have $\tau_4 > 0$. We set a new parameter v as follows: $\tau_3 = -v^2 \leq 0$ and we get $h = (4m^2 + 4u^2 + v^2)/8$. Calculations yield

$$\theta = 2[(4(m+u)^2 + v^2)(\tau_4 + uv^2), \quad \mu_0 = u[(4(m+u)^2 + v^2)]^2/16.$$

Hence due to the condition $\mu_0 > 0$ and $\tau_4 > 0$ we obtain $\theta > 0$ for any value of the parameter v . This completes the proof of the lemma. \square

Lemma 3.10. *if for a system (3.15) the condition $\mu_0 > 0$ holds then the condition $\tilde{M} = 0$ implies $W_2 > 0$ and $\mathcal{T}_2 \neq 0$.*

Proof. According to (3.16) the condition $\tilde{M} = 0$ implies $\mathcal{N}_1 = \mathcal{N}_2 = \mathcal{N}_3 = 0$. The equality $\mathcal{N}_1 = 0$ gives $h = [(2m - u)^2 - 3u]/6$ and then we obtain $\mathcal{N}_2 = [(2m - u)^3 + 27u^2] = 0$ and since $u \neq 0$ (due to $\mu_0 \neq 0$) we set two new parameters w as follows: $v = 2m - u \neq 0$ (i.e. $m = (u + v)/2$) and $u = vw$. Then we get $\mathcal{N}_2 = v^2(v + 27w^2)/6 = 0$ which yields $v = -27w^2$. So we obtain $m = -27w^2(1 + w)/2$, $u = -27w^3$ and $h = 27w^3(1 + 9w)/2$ and for these values of the parameters of systems (3.15) we get $\tilde{M} = 0$ and

$$W_2 = -3^{27}w^{27}(1 + 3w)^{16}(12w - 5)(15w - 4), \quad \mathcal{T}_2 = 3^{16}w^{14}(1 + 3w)^8, \quad \mu_0 = -3^9w^9(1 + 3w)^6.$$

Clearly due to $\mu_0 > 0$ we have $W_2 > 0$ and $\mathcal{T}_2 \neq 0$ and hence the lemma is proved. \square

The possibility $W_2 < 0$ In this case the anti-saddle is a focus and the existence of weak singularities depends on the invariant polynomial \mathcal{T}_2 .

1) The case $\mathcal{T}_2 \neq 0$. Then $\rho_3\rho_4 \neq 0$ and the saddle as well as the focus are strong ones. Therefore considering Lemmas 3.9, 3.10 and 3.1 we could only obtain the following 3 configurations:

- $s, f, \widehat{cp}_{(2)}; N^f, \odot, \odot$: Example \Rightarrow ((3.15): $h = 2, m = 0, u = 1$) (if $\eta < 0$);
- $s, f, \widehat{cp}_{(2)}; S, N^\infty, N^f$: Example \Rightarrow ((3.15): $h = 4, m = -5/2, u = 1$) (if $\eta > 0$);
- $s, f, \widehat{cp}_{(2)}; \binom{0}{2}SN, N^f$: Example \Rightarrow ((3.15): $h = (5 + 4\zeta^2)/8, m = \zeta, u = 1$) (where $\zeta = \eta^{-1}(0) \approx -1.474363$) (if $\eta = 0$).

2) The case $\mathcal{T}_2 = 0$. In this case we have at least one weak singularity.

a) The subcase $\mathcal{T}_1 \neq 0$. So by (3.16) only one singularity is weak and its type is governed by the invariant polynomial \mathcal{H} .

a₁) The possibility $\mathcal{H} < 0$. According to [28, Main Theorem, the statement (d)] we have a weak focus of order one and we obtain the following 3 configurations

- $s, f^{(1)}, \widehat{cp}_{(2)}; N^f, \odot, \odot$: Example \Rightarrow ((3.15): $h = 1, m = -2, u = 1$) (if $\eta < 0$);
- $s, f^{(1)}, \widehat{cp}_{(2)}; S, N^\infty, N^f$: Example \Rightarrow ((3.15): $h = 1/12, m = -13/12, u = 1/12$) (if $\eta > 0$);
- $s, f^{(1)}, \widehat{cp}_{(2)}; \binom{0}{2}SN, N^f$: Example \Rightarrow ((3.15): $h = (1 + 8\zeta^2)/8, m = -\zeta, u = \zeta$) (where $\zeta = \eta^{-1}(0) \approx 1.762699$) (if $\eta = 0$).

a₂) The possibility $\mathcal{H} > 0$. Then by [28] the weak singularity is a saddle of order one and we arrive at the following 3 configurations

- $s^{(1)}, f, \widehat{cp}_{(2)}; N^f, \odot, \odot$: Example \Rightarrow ((3.15): $h = 1, m = 0, u = 1$) (if $\eta < 0$);
- $s^{(1)}, f, \widehat{cp}_{(2)}; S, N^\infty, N^f$: Example \Rightarrow ((3.15): $h = 567/400, m = -6/5, u = 6/5$) (if $\eta > 0$);
- $s^{(1)}, f, \widehat{cp}_{(2)}; \binom{0}{2}SN, N^f$: Example \Rightarrow ((S₃): $b = 27/4, c = -3/2, d = -3/4, e = 3, f = 3/2, g = 5/4, h = 1$) (if $\eta = 0$).

b) The subcase $\mathcal{T}_1 = 0$. Then $\rho_3 = \rho_4 = 0$ and this implies $h = 0$ and $m = -u$. In this case for systems (3.15) we calculate

$$\sigma = \frac{\partial P}{\partial x} + \frac{\partial Q}{\partial y} = 0, \quad \eta = -108(u - 1)^2u^3, \quad \mu_0 = 4(u - 1)^2u^3.$$

So we get Hamiltonian systems which besides a cusp have a center and an integrable saddle. Since the condition $\mu_0 > 0$ implies $\eta < 0$ we obtain the unique configuration

- $s, c, \widehat{cp}_{(2)}; N^f, \odot, \odot$: Example \Rightarrow ((3.15): $h = 2, m = -2, u = 2$).

The possibility $W_2 > 0$ In this case the anti-saddle is a generic node and we consider two cases: $\mathcal{T}_2 \neq 0$ and $\mathcal{T}_2 = 0$.

1) The case $\mathcal{T}_2 \neq 0$. The saddle is strong.

a) The subcase $\eta < 0$. According to Lemmas 3.1 and 3.5 (the statement (iii)) there can only be 3 configurations:

- $s, n, \widehat{cp}_{(2)}; N^\infty, \odot, \odot$: Example \Rightarrow ((3.15): $h = -1, m = 1, u = 2$) (if $\theta < 0$);
- $s, n, \widehat{cp}_{(2)}; N^f, \odot, \odot$: Example \Rightarrow ((3.15): $h = -1, m = 0, u = 1$) (if $\theta > 0$);
- $s, n, \widehat{cp}_{(2)}; N^d, \odot, \odot$: Example \Rightarrow ((3.15): $h = 2(\sqrt{2} - 1), m = 0, u = 2$) (if $\theta = 0$).

b) The subcase $\eta > 0$. According to Lemmas 3.1 and 3.5 (the statement (iii)) there can only be 6 configurations:

- $s, n, \widehat{cp}_{(2)}; S, N^\infty, N^\infty$: Example \Rightarrow ((3.15): $h = -11/6, m = 5/3, u = 7/4$) (if $\theta < 0, \theta_1 < 0$);
- $s, n, \widehat{cp}_{(2)}; S, N^f, N^f$: Example \Rightarrow ((3.15): $h = 0, m = 3, u = 1$) (if $\theta < 0, \theta_1 > 0$);
- $s, n, \widehat{cp}_{(2)}; S, N^\infty, N^f$: Example \Rightarrow ((3.15): $h = 2, m = 3, u = 1$) (if $\theta > 0$);
- $s, n, \widehat{cp}_{(2)}; S, N^\infty, N^d$: Example \Rightarrow ((3.15): $h = (10\sqrt{13} - 13)/4, m = -7/4, u = 13/4$) (if $\theta = 0, \theta_1 < 0$);
- $s, n, \widehat{cp}_{(2)}; S, N^f, N^d$: Example \Rightarrow ((3.15): $h = 0, m = 2, u = 1$) (if $\theta = 0, \theta_1 > 0$);
- $s, n, \widehat{cp}_{(2)}; S, N^d, N^d$: Example \Rightarrow ((3.15): $h = -2, m = 2, u = 2$) (if $\theta = \theta_1 = 0$).

c) The subcase $\eta = 0$. In this case systems (3.3) possess at infinity either one double and one simple real singular points (if $\widetilde{M} \neq 0$) or one triple real singularity (if $\widetilde{M} = 0$). So by Lemmas 3.1 and Lemma 3.5 (the statement (iii)) we have the following 3 configurations:

- $s, n, \widehat{cp}_{(2)}; \binom{0}{2}SN, N^\infty$: Example \Rightarrow ((S_3): $b = -1, c = -2, d = 4, e = -1, f = 2, g = -3, h = 1$) (if $\theta < 0$);
- $s, n, \widehat{cp}_{(2)}; \binom{0}{2}SN, N^f$: Example \Rightarrow ((S_3): $b = -4, c = 1, d = 1, e = -1, f = -1, g = -3, h = 1$) (if $\theta > 0$);
- $s, n, \widehat{cp}_{(2)}; \binom{0}{2}SN, N^d$: Example \Rightarrow ((S_3): $b = -1/3, c = -2, d = 4/3, e = -3, f = 2, g = -1/3, h = 1$) (if $\theta = 0$)

if $\widetilde{M} \neq 0$ and one configuration

- $s, n, \widehat{cp}_{(2)}; \binom{0}{3}N$: Example \Rightarrow ((3.15): $h = 108, m = 0, u = 27$)

if $\widetilde{M} = 0$.

2) The case $\mathcal{T}_2 = 0$. Then the saddle is weak and we claim that in this case:

- (i) the weak saddle could only be of order one and the condition $\widetilde{M} \neq 0$ holds;
- (ii) the conditions $\theta = \theta_1 = 0$ and $\mu_0 \neq 0$ are incompatible.

Indeed, the condition $\mathcal{T}_2 = 0$ implies $\rho_3\rho_4 = 0$ and we may consider that $\rho_3 = 0$, i.e. for systems (3.15) we have $m = -u$. Then we calculate

$$\begin{aligned} \mu_0 &= 4u(h - u^2)^2, & \mathcal{F}_1 &= 4(h - u)u(h - u^2), \\ \theta &= 64(h - u^2)[(h + u)^2 - 4u^3], & \text{Coefficient}[\widetilde{M}, xy] &= -48(h - u)u \end{aligned}$$

and since $\mu_0 \neq 0$ the condition $\mathcal{F}_1 = 0$ as well as the condition $\widetilde{M} = 0$, implies $h = u$ and then $W_2 = -1024(-1 + u)^6u^9 < 0$ due to $\mu_0 > 0$, i.e. the claim (i) is proved.

Assume now that $\theta = 0$. Since $u \neq 0$ we set a new parameter v as follows: $h + u = 2uv$ and then the condition $\theta = 0$ gives $u = v^2$. In this case we calculate

$$\theta = 0, \quad \mu_0 = 4(v-1)^4 v^6, \quad \theta_1 = 512(v-1)^3 v^7$$

and since the condition $\mu_0 \neq 0$ implies $\theta_1 \neq 0$ the claim (ii) is proved.

a) *The subcase $\eta < 0$.* According to Lemmas 3.1 and 3.5 (the statement (iii)) there can only be 3 configurations:

- $s^{(1)}, n, \widehat{cp}_{(2)}; N^\infty, \odot, \odot$: Example \Rightarrow ((3.15): $h = 2, m = -5/6, u = 2$) (if $\theta < 0$);
- $s^{(1)}, n, \widehat{cp}_{(2)}; N^f, \odot, \odot$: Example \Rightarrow ((3.15): $h = 2, m = 1, u = 2$) (if $\theta > 0$);
- $s^{(1)}, n, \widehat{cp}_{(2)}; N^d, \odot, \odot$: Example \Rightarrow ((3.15): $h = 4, m = 0, u = 4$) (if $\theta = 0$).

b) *The subcase $\eta > 0$.* As it was mentioned above in the case $\theta = 0$ we have $\theta_1 \neq 0$ and according to Lemmas 3.1 and 3.5 (the statement (iii)) there can be only 5 configurations:

- $s^{(1)}, n, \widehat{cp}_{(2)}; S, N^\infty, N^\infty$: Example \Rightarrow ((3.15): $h = 100, m = 79, u = 100$) (if $\theta < 0, \theta_1 < 0$);
- $s^{(1)}, n, \widehat{cp}_{(2)}; S, N^f, N^f$: Example \Rightarrow ((3.15): $h = 1, m = 4, u = 1$) (if $\theta < 0, \theta_1 > 0$);
- $s^{(1)}, n, \widehat{cp}_{(2)}; S, N^\infty, N^f$: Example \Rightarrow ((3.15): $h = 2, m = 4, u = 2$) (if $\theta > 0$);
- $s^{(1)}, n, \widehat{cp}_{(2)}; S, N^\infty, N^d$: Example \Rightarrow ((3.15): $h = 100, m = 80, u = 100$) (if $\theta = 0, \theta_1 < 0$);
- $s^{(1)}, n, \widehat{cp}_{(2)}; S, N^f, N^d$: Example \Rightarrow ((3.15): $h = 1/4, m = -3/4, u = 1/4$) (if $\theta = 0, \theta_1 > 0$).

c) *The subcase $\eta = 0$.* Since $\widetilde{M} \neq 0$ in this case systems (3.3) possess at infinity one double and one simple real singular points. So by Lemmas 3.1 and Lemma 3.5 (the statement (iii)) we have the following 3 configurations:

- $s^{(1)}, n, \widehat{cp}_{(2)}; \binom{0}{2}SN, N^\infty$: Example \Rightarrow ((S_3): $b = -9/2, c = 1, d = 1/2, e = -2, f = -1, g = -11/2, h = 4$) (if $\theta < 0$);
- $s^{(1)}, n, \widehat{cp}_{(2)}; \binom{0}{2}SN, N^f$: Example \Rightarrow ((S_3): $b = -9/2, c = 1, d = 1/2, e = -2, f = -1, g = -5/2, h = 1$) (if $\theta > 0$);
- $s^{(1)}, n, \widehat{cp}_{(2)}; \binom{0}{2}SN, N^d$: Example \Rightarrow ((S_3): $b = -3/2, c = 1/3, d = 1/6, e = -2/3, f = -1/3, g = -3/2, h = 1$) (if $\theta = 0$).

The possibility $W_2 = 0$ We have a node with coinciding eigenvalues and we observe that it could not be a star node because the corresponding linear matrices for the elemental singularities are

$$\mathcal{M}_3 = \begin{pmatrix} u & 2h - u^2 \\ -1 & 2m + u \end{pmatrix}, \quad \mathcal{M}_4 = \begin{pmatrix} 2h - u & u^2 \\ 1 + 2m & -u \end{pmatrix},$$

with $u \neq 0$.

1) *The case $\mathcal{T}_2 \neq 0$.*

So according to Lemmas 3.10, 3.9 and 3.1 there can only be 3 configurations:

- $s, n^d, \widehat{cp}_{(2)}; N^f, \odot, \odot$: Example \Rightarrow ((3.15): $h = 1/2, m = 0, u = 1$) (if $\eta < 0$);
- $s, n^d, \widehat{cp}_{(2)}; S, N^\infty, N^f$: Example \Rightarrow ((3.15): $h = 5/2, m = -2, u = 1$) (if $\eta > 0$);
- $s, n^d, \widehat{cp}_{(2)}; \binom{0}{2}SN, N^f$: Example \Rightarrow ((S_3): $b = 4, c = -1, d = -1, e = 1, f = 1, g = 3/4, h = 5/4$) (if $\eta = 0$).

2) *The case $\mathcal{T}_2 = 0$.*

So according to Lemmas 3.10, 3.9 and 3.1 there can only be 3 configurations:

- $s^{(1)}, n^d, \widehat{cp}_{(2)}; N^f, \odot, \odot$: Example \Rightarrow ((3.15): $h = -1, m = -1, u = 1$) (if $\eta < 0$);

- $s^{(1)}, n^d, \widehat{c}p_{(2)}$; S, N^∞, N^f : Example \Rightarrow ((3.15): $h = 4/5, m = -2\sqrt{6}/5, u = 4/5$) (if $\eta > 0$);
- $s^{(1)}, n^d, \widehat{c}p_{(2)}; \overline{(0)}SN, N^f$: Example \Rightarrow ((3.15): $h = 81/125, m = -117/125, u = 81/125$) (if $\eta = 0$).

Thus we have examined all the possibilities for the family of systems possessing three distinct finite singularities of total multiplicity 4 and we proved the existence of 296 geometrically distinct configurations.

Acknowledgments

The first two authors are partially supported by a MINECO/FEDER grant MTM2008-03437, MINECO grant MTM2013-40998-P, an AGAUR grant number 2014SGR-568, an ICREA Academia, the grants FP7-PEOPLE-2012-IRSES 318999 and 316338, and the MINECO/FEDER grant UNAB13-4E-1604. The third author is supported by NSERC Grant RN000355. The fourth author is partially supported by the grant FP7-PEOPLE-2012-IRSES-316338 and by NSERC Grant RN000355.

References

- [1] J. C. ARTÉS, J. LLIBRE, D. SCHLOMIUK, The geometry of quadratic differential systems with a weak focus of second order, *Internat. J. Bifur. Chaos Appl. Sci. Engrg.* **16**(2006), No. 11, 3127–3194. [MR2288574](#); [url](#)
- [2] J. C. ARTÉS, J. LLIBRE, D. SCHLOMIUK, N. VULPE, From topological to geometric equivalence in the classification of singularities at infinity for quadratic vector fields, *Rocky Mountain J. Math.* **45**(2015), No. 1, 29–113. [MR3334204](#); [url](#)
- [3] J. C. ARTÉS, J. LLIBRE, D. SCHLOMIUK, N. VULPE, Configurations of singularities for quadratic differential systems with total finite multiplicity lower than 2, *Bul. Acad. Ştiinţe Repub. Mold. Mat.* **71**(2013), No. 1, 72–124. [MR3155835](#)
- [4] J. C. ARTÉS, J. LLIBRE, D. SCHLOMIUK, N. VULPE, Geometric configurations of singularities for quadratic differential systems with total finite multiplicity $m_f = 2$, *Electron. J. Differential Equations* **2014**, No. 159, 1–79. [MR3239402](#)
- [5] J. C. ARTÉS, J. LLIBRE, D. SCHLOMIUK, N. VULPE, Global configurations of singularities for quadratic differential systems with total finite multiplicity three and at most two real singularities, *Qual. Theory Dyn. Syst.* **13**(2014), No. 2, 305–351. [MR3265338](#); [url](#)
- [6] J. C. ARTÉS, J. LLIBRE, D. SCHLOMIUK, N. VULPE, Geometric configurations of singularities for quadratic differential systems with three distinct real simple finite singularities. *J. Fixed Point Theory Appl.* **14**(2013), No. 2, 555–618. [MR3248570](#); [url](#)
- [7] J. C. ARTÉS, J. LLIBRE, A. C. REZENDE, D. SCHLOMIUK, N. VULPE, Global configurations of singularities for quadratic differential systems with exactly two finite singularities of total multiplicity four, *Electron. J. Qual. Theory Differ. Equ.* **2014**, No. 60, 1–43. [MR3296521](#)
- [8] J. C. ARTÉS, J. LLIBRE, N. I. VULPE, Singular points of quadratic systems: a complete classification in the coefficient space \mathbb{R}^{12} , *Internat. J. Bifur. Chaos Appl. Sci. Engrg.* **18**(2008), No. 2, 313–362. [MR2404306](#); [url](#)

- [9] J. C. ARTÉS, J. LLIBRE, N. VULPE, Complete geometric invariant study of two classes of quadratic systems, *Electron. J. Differential Equations* **2012**, No. 9, 1–35. [MR2889615](#)
- [10] J. C. ARTÉS, J. LLIBRE, N. VULPE, Quadratic systems with an integrable saddle: a complete classification in the coefficient space \mathbb{R}^{12} , *Nonlinear Anal.* **75**(2012), No. 14, 5416–5447. [MR2942928](#); [url](#)
- [11] V. BALTAG, Algebraic equations with invariant coefficients in qualitative study of the polynomial homogeneous differential systems, *Bul. Acad. Ştiinţe Repub. Mold. Mat.* **2**(2003), 31–46 [MR1995424](#)
- [12] N. N. BAUTIN, On the number of limit cycles which appear with the variation of coefficients from an equilibrium position of focus or center type, *Mat. Sb. (N.S)* **30(72)**(1952), 181–196 (in Russian) [MR0045893](#), American Math. Soc. Translation **1954**, No. 100, 397–413. [MR0059426](#)
- [13] IU. CALIN, On rational bases of $GL(2, \mathbb{R})$ -comitants of planar polynomial systems of differential equations, *Bul. Acad. Ştiinţe Repub. Mold. Mat.* **2**(2003), No. 2, 69–86. [MR1995429](#)
- [14] B. COLL, *Qualitative study of some classes of vector fields in the plane*, Ph.D. thesis, Universitat Autònoma de Barcelona, (1987), 5–34.
- [15] F. DUMORTIER, J. LLIBRE, J. C. ARTÉS, *Qualitative theory of planar differential systems*, Universitext, Springer-Verlag, New York–Berlin, 2006, 298 pp. [MR2256001](#)
- [16] E. A. GONZÁLEZ VELASCO, Generic properties of polynomial vector fields at infinity, *Trans. Amer. Math. Soc.* **143**(1969), 201–222. [MR0252788](#)
- [17] Q. JIANG, J. LLIBRE, Qualitative classification of singular points, *Qual. Theory Dyn. Syst.* **6**(2005), No. 1, 87–167. [MR2273491](#); [url](#)
- [18] J. LLIBRE, D. SCHLOMIUK, Geometry of quadratic differential systems with a weak focus of third order, *Canad. J. Math.* **56**(2004), No. 2, 310–343. [MR2040918](#); [url](#)
- [19] I. NIKOLAEV, N. VULPE, Topological classification of quadratic systems at infinity, *J. London Math. Soc. (2)* **55**(1997), No. 3, 473–488. [MR1452259](#); [url](#)
- [20] J. PAL, D. SCHLOMIUK, Summing up the dynamics of quadratic Hamiltonian systems with a center, *Canad. J. Math.* **56**(1997), 583–599. [MR1451262](#); [url](#)
- [21] M. N. POPA, *Metode cu algebre la sisteme diferenţiale* (in Romanian) [Applications of algebraic methods to differential systems], Editura The Flower Power, Piteşti, 2004, 340 pp. [MR2111006](#)
- [22] M. N. POPA, K. S. SIBIRSKII, Conditions for the existence of a homogeneous linear partial integral of a differential system, *Differentsial'nye Uravneniya* **23**(1987), No. 8, 1324–1331 (in Russian), English translation in: *Differential Equations* **23**(1987), No. 8, 894–900. [MR909578](#)
- [23] D. SCHLOMIUK, Algebraic and geometric aspects of the theory of polynomial vector fields, in: D. Schlomiuk (ed.), *Bifurcations and periodic orbits of vector fields (Montreal, PQ, 1992)*, NATO Adv. Sci. Inst. Ser. C Math. Phys. Sci. Vol. 408, Kluwer Academic Publishers, 1993, 429–467. [MR1258526](#)

- [24] D. SCHLOMIUK, J. PAL, On the geometry in the neighborhood of infinity of quadratic differential systems with a weak focus, *Qual. Theory Dyn. Syst.* **2**(2001), No. 1, 1–43. [MR1844975](#); [url](#)
- [25] D. SCHLOMIUK, N. I. VULPE, Geometry of quadratic differential systems in the neighborhood of infinity, *J. Differential Equations* **215**(2005), No. 2, 357–400. [MR2147466](#); [url](#)
- [26] K. S. SIBIRSKII, *Introduction to the algebraic theory of invariants of differential equations* (Translated from the Russian), Nonlinear Science: Theory and Applications, Manchester University Press, Manchester, 1988, viii+169 pp. [MR981596](#)
- [27] A. P. VOROBIEV, Behavior of integral curves in the neighborhood of infinity (in Russian), *Vesci Akad. Navuk BSSR Ser. Fiz.-Tehn. Navuk*, **1961**, No. 2, 20–30. [MR0133504](#)
- [28] N. VULPE, Characterization of the finite weak singularities of quadratic systems via invariant theory, *Nonlinear Anal.* **74**(2011), No. 17, 6553–6582. [MR2834062](#); [url](#)
- [29] N. I. VULPE, *Polynomialnye bazisy komitantov differentsialnykh sistem i ikh prilozheniya v kachestvennoi teorii* (in Russian) [Polynomial bases of comitants of differential systems and their applications in qualitative theory], “Știința”, Kishinev, 1986, 172 pp. [MR854675](#)