

## Research Article

# Complex Dynamics in a Growth Model with Corruption in Public Procurement

**Serena Brianzoni, Raffaella Coppier, and Elisabetta Michetti**

*Dipartimento di Istituzioni Economiche e Finanziarie, Università di Macerata, Via Crescimbeni 20, 62100 Macerata, Italy*

Correspondence should be addressed to Elisabetta Michetti, michetti@unimc.it

Received 24 May 2010; Accepted 15 January 2011

Academic Editor: Changhong Wang

Copyright © 2011 Serena Brianzoni et al. This is an open access article distributed under the Creative Commons Attribution License, which permits unrestricted use, distribution, and reproduction in any medium, provided the original work is properly cited.

We study the relationship between corruption in public procurement and economic growth within the Solow framework in discrete time, while assuming that the public good is an input in the productive process and that the State fixes a monitoring level on corruption. The resulting model is a bidimensional triangular dynamic system able to generate endogenous fluctuations for certain values of some relevant parameters. We study the model from the analytical point of view and find that multiple equilibria with nonconnected basins are likely to emerge. We also perform a stability analysis and prove the existence of a compact global attractor. Finally, we focus on local and global bifurcations causing the transition to more and more complex asymptotic dynamics. In particular, as our map is nondifferentiable in a subset of the states space, we show that border collision bifurcations occur. Several numerical simulations support the analysis. Our study aims at demonstrating that no long-run equilibria with zero corruption exist and, furthermore, that periodic or aperiodic fluctuations in economic growth are likely to emerge. As a consequence, the economic system may be unpredictable or structurally unstable.

## 1. Introduction

Many modern States use procurement in order to obtain goods and services that they deem necessary to support their public policy actions, one of which being to support productive activity. But this procurement is not immune to manipulation through corruption. As Rose-Ackerman [1] stressed when the government is a buyer or a contractor, there are several reasons to pay off officials: a firm may pay to be included in the list of qualified bidders, it may pay to have officials structure bidding specifications, or it may pay to get inflated prices or to skimp on quality.

In our model, we deal with the relationship between corruption in public procurement and economic growth. Although the issue of corruption in public procurement is very relevant, it has only recently attracted a lot of attention. To be more precise, the existing

literature has been concerned with the effect of corruption on public procurement (e.g., [2]) or with the effect of the presence of public goods on economic growth, as an input to private production (e.g., [3]). Unlike previous works, we consider the role of corruption in public procurement and its effects on growth via a reduction in the quality of public infrastructure and services supplied to the private sector. Public procurement is typically organized by a bureaucrat on behalf of the State who delegates the public good's purchase to a bureaucrat, via reverse auction for the procurement of a public good. The provision of the good is awarded to the firm which offers the highest quality good in the sealed bid: we assume that the public good can be produced at different quality levels (low quality and high quality). As a general rule, the firm which offers the highest quality wins the auction. The corrupt bureaucrat can, when announcing the winner, lie about the quality of the public good in exchange for a bribe.

Our paper analyzes the consequences of corruption on public procurement in a discrete-time Solow growth model, considering that corruption, in lowering the quality of the public good, can reduce economic growth. We consider the capital intensive Cobb-Douglas production function while assuming that the quality of the public good, used as an input in the productive process, affects the total productivity factor (one unit of the high-quality public good generates more units of the private good by means of the greater total productivity factor). Like Del Monte and Papagni [4], we introduce a public input into the production function, assuming that the supply of public input is affected by corruption, which harms the efficiency of public expenditure.

Del Monte and Papagni [4] fix the amount of corruption exogenously, in the sense that they consider that the private sector can count only on a share of public good production while corrupt agents take the rest. Unlike them, we assume that firms which produce the public good differ with respect to their "shame cost," hence we endogenize the level of corruption, while determining the fraction of firms which produce the low-quality public good by solving a one-shot game via the backward induction method.

Following more recent contributions to the literature (e.g., [5]), we consider that the ex ante quality of a public good is the private information of firms, and only after checks by a controller is the quality verifiable. Then, the State, in order to weed out or reduce corruption, monitors bureaucrats' behavior through controllers and fixes the monitoring level by comparing the marginal benefit of corruption controls with the cost of actually doing it. In detail, the State fixes the monitoring level by considering the current level of corruption, the benefit of reduction of corruption, the costs associated with monitoring activity, and the problem of a cogent public budget constraint that represents a limit to the use of public resources allocated to the control of corruption. The resulting two-dimensional, discrete time, nonlinear dynamic system will be studied both from the analytical and the numerical points of view. As far as the fixed points owned by the system are concerned, we will prove that multiple equilibria are likely to emerge. In particular, a locally stable fixed point in which all firms are corrupt does exist if budget constraint is cogent enough. Other fixed points with low or high equilibrium corruption can be exhibited, and we will provide conditions relating to the parameters for their existence. We will also perform a local stability analysis in order to state conditions for the equilibria to be locally asymptotically stable. Furthermore, we show conditions for our system having a compact global attractor.

In order to show how cyclical or complex fluctuations may be produced in our model, we will consider several kinds of bifurcations. In particular, as our map is piecewise smooth, the state space is divided into two regions, and, for some parameter values, a fixed or periodic point may collide with the borderline, and this may lead to a so-called border

collision bifurcation. We will prove that border collision bifurcations will occur as some parameters vary. In addition, as multiple attractors can coexist in our model, we will show how the structure of the basins of attraction can change because of the occurrence of contact bifurcations. We will also perform a mainly numerical analysis to describe the bifurcations which increase the complexity of the asymptotic dynamic behaviour of the system.

Our study aims at confirming that the presence of corruption in public procurement produces long-run equilibria in which corrupt firms survive. Furthermore, it can represent a source of endogenous instability in economic growth since periodic or aperiodic fluctuations are likely to emerge. As a consequence, the economic system may be unpredictable or structurally unstable.

The paper is organized as follows. In Section 2 we discuss the underlying assumptions, and we present the two-dimensional triangular map describing the economic growth evolution relating to the dynamics of the corruption level. In Section 3 we determine the number of fixed points in our system and find that multiple equilibria can be presented. We also arrive at some preliminary results about their local stability and point out the occurrence of a rich variety of local bifurcations. In Section 4 we prove some general results concerning the global dynamics of the system, in particular the existence of the compact global attractor. Section 5 is devoted to the study of the local and global bifurcations which cause the transition to more and more complex asymptotic dynamics.

## 2. The Model

Consider an economy composed by three types of players: the State, bureaucrats, and private firms. We assume that all economic agents are risk-neutral. Then two types of private firms are considered: the one-(j-type)-producing a private good and the other-(i-type)-producing a public good. In order to provide the public good for the private j-type firms, the State must buy the public good from the private i-type firms. We assume that at any time  $t = 1, 2, \dots$  the State procures a unit of public good from each private i-type firm in order to provide it free to j-type firms.

### 2.1. Game Description and Solution

The public good can be produced at different quality levels (low-quality public good and high-quality public good). For the nature of public good, for example, infrastructure, we assume that it is not any possible kind of arbitrage on the purchased inputs. We assume that the public good's price, at any time  $t = 1, 2, \dots$ , is constant and given by  $p_t = p$ , for all  $t$ , and let i-type firms compete over the good's quality: the higher the quality offered, the lower the profit for i-type firms and the higher the welfare for the community. Following Bose et al. [6], the constant cost of production for an i-type firm is such that if the public good's quality is high the unit cost  $c^h$  is also high, while if the public good's quality is low, the unit cost  $c^l$  is too, that is,  $c^h > c^l$ . Furthermore, the production of public goods is assumed to be profitable, that is,  $p > c^h$ . Each i-type firm produces one unit of public good. We assume that i-type firms differ with respect to their "shame costs"—for the social stigma associated with being found guilty—hence with  $m^i \in [0, 1]$ , we indicate the specific  $i$ -th entrepreneur "shame costs" that we assume to be constant in time. In addition, we assume that i-type firms are uniformly distributed with respect to their "shame costs," hence  $m^i$  represents the fraction of firms with "shame costs" lesser or equal to  $m^i$ .

The bureaucrat receives a salary  $w$ . It is assumed that no arbitrage is possible between the public and the private sector and that therefore there is no possibility for the bureaucrats to become entrepreneurs, even if their salaries  $w$  were lower than the entrepreneur's net return. This happens because the bureaucrat individuals in the population have no access to capital markets, but only a job, and therefore may not become entrepreneurs. The bureaucrats organize a reverse auction for the procurement of the public good, and the provision of the good is awarded to the firm which offers the highest quality good in the sealed bid. Only the bureaucrat observes the firms' sealed bids. As a general rule, the firm which offers the highest quality wins the auction. The corrupt bureaucrat can, when proclaiming the winner, lie about the quality of the public good in exchange for a bribe  $b$ . Let  $b^d$  be the bribe demanded by the bureaucrat. Then, the firm can refuse to pay the bribe or agree to pay and start negotiating the bribe with the bureaucrat. The State, in order to weed out or reduce corruption, monitors bureaucrats: in fact, at any time  $t$  there is an endogenous probability  $q_t$  of being monitored according to the control level fixed by the State and, then, of being reported.

The firm, if detected, must supply the high-quality public good, pay the "shame cost," but it is refunded the cost of the bribe while the bureaucrat must only return the bribe. This assumption can be more easily understood when, rather than corruption, there is extortion by the bureaucrat, even though, in many countries, the relevant provisions or laws stipulate that the bribe shall in any case, be returned to the entrepreneur and that combined minor punishment (penal and/or pecuniary) be inflicted on him/her. The results do not depend on the existence of a cost for the bureaucrat detected in a corrupt transaction. To simplify the results, we have preferred to omit this. The economic problem can be formalized with a game tree which shows the interaction between the bureaucrat and the  $i$ -th firm which produces one unit of public good. In what follows, we refer to the bureaucrat payoff by a superscript (1) and to the  $i$ -th firm payoff by a superscript (2): they represent, respectively, the first and the second element of the payoff vector  $\underline{\pi}_{n,t}$ ,  $n = 1, 2, 3$  at time  $t$ .

The timing of the game is as follows.

- (1) In the first stage of the game, the bureaucrat decides the amount to ask for as a bribe  $b_t^d$  to award the bid. The bureaucrats, if indifferent whether to ask for a bribe or not, will prefer to be honest.

- (1.1) If the bureaucrat decides not to ask for a bribe ( $b_t^d = 0$ ) to award the bid, then the game ends and the payoff vector for bureaucrat and entrepreneur at time  $t$  is

$$\underline{\pi}_{1,t} = (\pi_{1,t}^{(1)}, \pi_{1,t}^{(2)}) = (w, p - c^h). \quad (2.1)$$

- (1.2) If the bureaucrat decides to ask for a bribe ( $b_t^d > 0$ ), the game continues to stage two.

- (2) At stage two, the entrepreneur should decide whether to negotiate the bribe to be paid to the bureaucrat or to refuse to pay the bribe. Should he decide to carry out a negotiation with the bureaucrat, the two parties will find the bribe corresponding to the Nash solution to a bargaining game ( $b_t^{NB}$ ), and the game ends. At time  $t$ , the payoffs will depend on whether the bureaucrat and the entrepreneur are monitored (with probability  $q_t$ ) or not (with probability  $1 - q_t$ ).

(2.1) If the entrepreneur refuses the bribe, then the payoff vector, at time  $t$ , is given by

$$\underline{\pi}_{2,t} = (\pi_{2,t}^{(1)}, \pi_{2,t}^{(2)}) = (\omega, p - c^h). \quad (2.2)$$

Then the game ends.

(2.2) Otherwise the negotiation starts. Let  $b_i^{NB}$  be the final equilibrium bribe associated to the Nash solution to a bargaining, that is, the result of the negotiation. Then, at time  $t$ , given the probability level  $q_t$  of being detected, the expected payoff vector is

$$\underline{\pi}_{3,t} = (\pi_{3,t}^{(1)}, \pi_{3,t}^{(2)}) = (\omega + (1 - q_t)b_i^{NB}, p - (1 - q_t)c^l - (1 - q_t)b_i^{NB} - q_t c^h - q_t m^i). \quad (2.3)$$

The game ends.

The one-shot game previously described may be solved by backward induction, starting from the last stage of the game. At any time  $t$ , the bribe resulting as the Nash solution to a bargaining game in the last subgame should be determined. This bribe is the outcome of a negotiation between the bureaucrat and the entrepreneur. In the following proposition we determine the equilibrium bribe  $b_i^{NB}$ .

**Proposition 2.1.** *Let  $q_t \neq 1$ . Then there exists a unique bribe ( $b_i^{NB}$ ), as the Nash solution to a bargaining game, given by*

$$b_i^{NB} = \tau \left[ (c^h - c^l) - \frac{q_t}{(1 - q_t)} m^i \right], \quad (2.4)$$

where  $\tau \equiv \varepsilon / (\lambda + \varepsilon)$  is the share of the surplus that goes to the bureaucrat and  $\varepsilon$  and  $\lambda$  are the parameters that can be interpreted as the bargaining strength measures, of the firm and the bureaucrat, respectively.

*Proof.* Let  $\underline{\pi}_{\Delta,t} = \underline{\pi}_{3,t} - \underline{\pi}_{2,t} = (\pi_{\Delta,t}^{(1)}, \pi_{\Delta,t}^{(2)})$  be the vector of the differences in the payoffs between the case of agreement and disagreement about the bribe, between bureaucrat and entrepreneur. In accordance with generalized Nash bargaining theory, the division between two agents will solve

$$\max_{b_i \in \mathbb{R}^+} \left( [\pi_{\Delta,t}^{(1)}]^\varepsilon \cdot [\pi_{\Delta,t}^{(2)}]^\lambda \right) \quad (2.5)$$

in formula

$$\max_{b_i \in \mathbb{R}^+} \left( [(1 - q_t)b_i]^\varepsilon \left[ -(1 - q_t)c^l - (1 - q_t)b_i - q_t c^h - q_t m^i + c^h \right]^\lambda \right), \quad (2.6)$$

that is, the maximum of the product between the elements of  $\underline{\pi}_{\Delta,t}$  and where  $[\omega, p - c^h]$  is the point of disagreement, that is, the payoffs that the entrepreneur and the bureaucrat,

respectively, would obtain if they did not come to an agreement. The parameters  $\varepsilon$  and  $\lambda$  can be interpreted as measures of bargaining strength. It is now easy to check that the bureaucrat gets a share  $\tau = \varepsilon/(\lambda + \varepsilon)$  of the surplus  $\pi$ , that is, the bribe is  $b = \tau\pi$ . Then the bribe  $b_t^{NB}$  is an asymmetric (or generalized) Nash bargaining solution and is given by

$$b_t^{NB} = \tau \left[ (c^h - c^l) - \frac{q_t}{(1 - q_t)} m^i \right], \quad (2.7)$$

that is, the unique equilibrium bribe in the last subgame, for all  $q_t \neq 1$ .  $\square$

As a consequence of the model, let us assume that the bureaucrat and the firm share the surplus on an equal basis. This is the standard Nash case, when  $\lambda = \varepsilon = 1$  and bureaucrat and firm get equal shares. In this case the bribe is

$$b_t^{NB} = \frac{1}{2} \left[ (c^h - c^l) - \frac{q_t}{(1 - q_t)} m^i \right]. \quad (2.8)$$

In other words, the bribe represents 50 percent of surplus.

Hence, the payoff vector at time  $t$  is given by

$$\underline{\pi}_{3,t} = \left( w + \frac{(c^h - c^l)(1 - q_t)}{2} - \frac{q_t}{2} m^i, p - \frac{(1 - q_t)(c^h + c^l)}{2} - \frac{q_t}{2} m^i - q_t c^h \right). \quad (2.9)$$

By solving the static game, we can prove the following proposition.

**Proposition 2.2.** *Let  $0 \leq m_t = (1 - q_t)(c^h - c^l)/q_t$ . Then,*

- (a) *if  $m_t \geq 1$ , that is,  $q_t \leq (c^h - c^l)/(1 + (c^h - c^l))$ , all the private firms produce low-quality public good;*
- (b) *if  $m_t < 1$ , that is,  $q_t > (c^h - c^l)/(1 + (c^h - c^l))$ , then  $m_t(1 - m_t)$  private firms produce a low (high) quality public good.*

*Proof.* (backward induction method). The static game is solved with the backward induction method, which allows identification of the equilibria. Starting from stage 3, the entrepreneur needs to decide whether to negotiate with the bureaucrat. Both payoffs are then compared, because the bureaucrat asked for a bribe.

- (2) At stage two, the entrepreneur negotiates the bribe if, and only if,

$$\begin{aligned} \underline{\pi}_{3,t}^{(2)} \geq \underline{\pi}_{2,t}^{(2)} &\implies \\ \left( p - \frac{(1 - q_t)c^l}{2} - \frac{(1 + q_t)c^h}{2} - \frac{q_t m^i}{2} \right) &> p - c^h \implies \\ m^i < \frac{(c^h - c^l)(1 - q_t)}{q_t} &= m_t. \end{aligned} \quad (2.10)$$

(1) Going up the decision-making tree, at stage one the bureaucrat decides whether to ask for a positive bribe.

(i) Let  $m^i < (c^h - c^l)(1 - q_t)/q_t = m_t$ ; then the bureaucrat knows that if he asks for a positive bribe, the entrepreneur will accept the negotiation, and the final bribe will be  $b_t^{NB}$ . Then, the bureaucrat asks for a bribe if, and only if,

$$\underline{\pi}_{3,t}^{(1)} > \underline{\pi}_{1,t}^{(1)} \implies w + \frac{(c^h - c^l)(1 - q_t)}{2} - \frac{q_t m^i}{2} > w, \quad (2.11)$$

that is, the bureaucrat's payoff. If  $m^i < (c^h - c^l)(1 - q_t)/q_t = m_t$ , then (2.11) is always verified. Then, the bureaucrat asks for the bribe  $b_t^{NB}$ , that the entrepreneur will accept. The expected payoff vector is given by

$$\underline{\pi}_{3,t} = \left( w + \frac{(c^h - c^l)(1 - q_t)}{2} - \frac{q_t m^i}{2}, p - \frac{(1 - q_t)(c^h + c^l)}{2} - \frac{q_t m^i}{2} - q_t c^h \right). \quad (2.12)$$

The game ends in the equilibrium with corruption, and the  $i$ -th entrepreneur produces low-quality goods.

(ii) Let  $m^i \geq (c^h - c^l)(1 - q_t)/q_t = m_t$ ; then the bureaucrat knows that the entrepreneur will not accept any possible bribe, so he will be honest, and the firm must sell the product at a high level of quality. The payoff vector for the entrepreneurs and bureaucrats is

$$\underline{\pi}_{1,t} = (w, p - c^h). \quad (2.13)$$

The game ends in the equilibrium with no corruption.

Trivially, if  $m_t \geq 1$  then  $m^i < m_t$ , for all  $i$ , hence all private firms produce the low-quality public good.  $\square$

According to our previous result, the entrepreneurs with moral costs  $m^i \leq m_t$  are corrupt while the entrepreneurs with "shame costs"  $m^i > m_t$  are honest. Since we assume that  $i$ -type firms are uniformly distributed with respect to their "shame costs" then  $m_t$  represents the fraction of corrupt entrepreneurs.

## 2.2. The Dynamic System

Consider now the  $j$ -type firms producing the private good and normalize their number to one. At any time  $t = 1, 2, \dots$ , following Barro [3], the private good is produced by using two production factors, the capital  $K_t$  and the public good. Hence a fraction  $m_t$  ( $1 - m_t$ ) of public good available to  $j$ -type firms to produce the private good is of low (high) quality; then we can consistently assume that, at any time,  $j$ -type firms use a fraction  $m_t$  of low-quality public input and a fraction  $(1 - m_t)$  of high-quality public input to produce the final private good. We capture these quality differences through differences in the total productivity factor so that the total productivity, in the case of the high-quality public good used ( $A_h$ ), is higher



than in the case of the low-quality public good ( $A_l$ ). In order to study the effect of corruption in procurement on economic growth, we consider the Solow neoclassical growth model in discrete time (see [7]). Hence, let  $y_t^l = \phi^l(k_t)$  ( $y_t^h = \phi^h(k_t)$ ) be the production function to produce a private good by using a low (high) quality public good as an input, where  $y_t = Y_t/L_t$  is the output per worker while  $k_t = K_t/L_t$  is the capital-labor ratio (i.e., capital per capita). Obviously for all  $k_t$  we have that  $y_t^l < y_t^h$  since the use of high-quality inputs implies greater production. Hence the final output per capita is given by

$$y_t = m_t \phi^l(k_t) + (1 - m_t) \phi^h(k_t). \quad (2.14)$$

In particular, using the Cobb-Douglas production function, we obtain  $\phi^l(k_t) = A_l k_t^\rho$  and  $\phi^h(k_t) = A_h k_t^\rho$  with  $A_h > A_l$ . Substituting in (2.14) we obtain

$$y_t = m_t A_l (k_t)^\rho + (1 - m_t) A_h (k_t)^\rho, \quad \rho \in (0, 1). \quad (2.15)$$

Each year, the  $j$ -type firms invest the fraction of their profits which remains after consumption, that is, saving adds to the capital stock (saving is equal to investment). Following the Solow framework, we consider the capital accumulation as given by the following formula:

$$k_{t+1} = \frac{1}{1+n} [s y_t + (1 - \delta) k_t], \quad (2.16)$$

where  $n > 0$  is the exogenous population growth rate while  $s \in (0, 1)$  is the constant saving ratio and  $\delta \in [0, 1]$  is the depreciation rate of capital.

In order to reduce corruption, the State checks the public procurement: it fixes the monitoring level comparing the marginal benefit due to the reduction of corruption level with the cost of doing it. More precisely, the State observes the corruption level at time  $t$  and decides the monitoring level for time  $t + 1$ . In other words, the monitoring level of the next year  $q_{t+1}$  is a function of the current level of corruption

$$q_{t+1} = \omega(m_t). \quad (2.17)$$

In order to determine  $q_{t+1}$ , the State has to take into account the benefit of a reduction in the corruption level, the costs associated with the monitoring activity, and the problem of a cogent public budget constraint. Obviously, the monitoring level  $q_{t+1}$  increases as the corruption level increases, while it decreases as the monitoring costs increase. We state some assumptions about the cost function: costs are assumed to be null in the case of absence of corruption, as it naturally should be. Moreover, we assume that the marginal costs of monitoring activity increase as the corruption level increases. Indeed, comprehensive monitoring activity implies increased costs, since it requires more sophisticated action and specialized knowledge about complex corrupt transactions. In addition, we consider the existence of a public budget constraint that represents a limit to the use of public resources allocated to the control of corruption. In particular, as corruption spreads to all firms, the State cannot monitor them all because of increasing marginal costs of monitoring, and, therefore, the monitoring level for a completely corrupt population (total corruption case) is less than



one and depends on how cogent the budget constraint is. A monitoring function  $\omega$  having the previous properties may satisfy the following conditions:

- (i)  $\omega(0) = 0$ ;
- (ii)  $\omega(1) = \tilde{q} < 1$ ;
- (iii)  $\tilde{m}_t \in (0, 1)$  exists such that  $\omega'(m_t) > 0$  ( $< 0$ ), if  $m_t < \tilde{m}_t$  ( $m_t > \tilde{m}_t$ );
- (iv)  $0 \leq \omega(m_t) \leq 1$ , for all  $m_t \in [0, 1]$ ;
- (v)  $\omega(m_t) = \tilde{q}$ , for all  $m_t > 1$ .

The following function enjoys all these properties:

$$q_{t+1} := \begin{cases} m_t - \mu(m_t)^\alpha & \text{if } m_t < 1, \\ 1 - \mu & \text{if } m_t \geq 1 \end{cases} \quad (2.18)$$

with  $\mu \in (0, 1)$  and  $\alpha > 1$ , where  $\omega'(m_t) = 1 - \mu\alpha(m_t)^{\alpha-1}$ , hence  $\tilde{m}_t = (\mu\alpha)^{1/(1-\alpha)}$  is the corruption level at which monitoring is maximum.

Function (2.18) takes into account two opposite effects. On the one hand, as corruption increases, the monitoring cost increases, and then the optimal monitoring level decreases; on the other hand, as corruption increases, the monitoring level increases. Unifying these two opposite channels we will show that there is a threshold value of corruption where the probability of being reported reaches a maximum. For corruption levels lower than this threshold value, the probability of being detected increases with respect to the corruption level. Indeed, the increase in the probability of being detected—due to the benefits of a reduction in corruption—overtakes the reduction in monitoring level—due to the increasing monitoring cost. Vice versa for corruption levels higher than this threshold value, the growing monitoring costs overtake the increase in the benefit of reducing corruption, then the probability of being reported decreases. In addition, we consider the existence of a public budget constraint that represents a limit to the use of public resources allocated to the control of corruption. Indeed, lower  $\mu$  means that public budget constraint is less cogent, and therefore the State can, *ceteris paribus*, put in place a higher monitoring level (with total corruption the monitoring level is different from one because of the public budget constraint). Notice the role of  $\alpha$ : this parameter represents the rate of growth of marginal costs of carrying out monitoring activity.

In order to determine the final dynamic model describing the economic growth in a context with corruption in public procurement, we first consider the case in which  $m_t < 1$ . By substituting (2.14) in formula (2.16) we obtain the discrete time dynamic equation describing the evolution of capital per capita  $k_t$ . As far as the evolution of the fraction  $m_t$  of corrupt firms is concerned, by taking into account Proposition 2.2 and defining  $\Delta c = c^h - c^l$  we have that  $q_{t+1} = \Delta c / (\Delta c + m_{t+1})$ , hence, while considering (2.18), we get

$$m_{t+1} = \frac{\Delta c}{m_t - \mu(m_t)^\alpha} - \Delta c \quad (2.19)$$

representing the dynamic equation describing the evolution of  $m_t$ .

Observe also that, if  $m_t \geq 1$ , then, as stated in Proposition 2.2, all firms are corrupt (i.e.,  $m_t = 1$  for all  $m_t \geq 1$ ).

Define  $\Delta A = A_h - A_l$  being the difference in the total productivity factors of using the two inputs; finally we obtain the following two-dimensional dynamic systems:

$$T_1 = \begin{cases} m_{t+1} = \frac{\Delta c}{m_t - \mu(m_t)^\alpha} - \Delta c \\ k_{t+1} = \frac{1}{1+n} [s k_t^\rho (A_h - m_t \Delta A) + (1-\delta)k_t] \end{cases} \quad \text{if } m_t < 1, \quad (2.20)$$

$$T_2 = \begin{cases} m_{t+1} = \frac{\mu \Delta c}{1-\mu} \\ k_{t+1} = \frac{1}{1+n} [s A_l k_t^\rho + (1-\delta)k_t] \end{cases} \quad \text{if } m_t \geq 1.$$

### 3. Fixed Points and Their Stability

As described at the end of the previous section, the time evolution of the capital per capita and of the fraction of corrupt firms is obtained by the iteration of a two-dimensional nonlinear map  $T : (m_t, k_t) \rightarrow (m_{t+1}, k_{t+1})$  given by

$$T = \begin{cases} g(m_t), \\ f(k_t, m_t), \end{cases} \quad (3.1)$$

where

$$g := \begin{cases} g_1 = \frac{\Delta c}{m_t - \mu(m_t)^\alpha} - \Delta c & \text{if } m_t < 1, \\ g_2 = m_c & \text{if } m_t \geq 1 \end{cases} \quad (3.2)$$

being  $m_c = \mu \Delta c / (1 - \mu)$  and

$$f := \begin{cases} f_1 = \frac{1}{1+n} [s k_t^\rho (A_h - m_t \Delta A) + (1-\delta)k_t] & \text{if } m_t < 1, \\ f_2 = \frac{1}{1+n} [s A_l k_t^\rho + (1-\delta)k_t] & \text{if } m_t \geq 1. \end{cases} \quad (3.3)$$

As it is easy to verify,  $T$  is a continuous and piecewise smooth map, that is, it is non-differentiable in points belonging to the line  $m_t = 1$ , which separates the state space into two regions:  $R_1 = \{(m, k) : m < 1\}$  and  $R_2 = \{(m, k) : m > 1\}$ . We also observe that the first component of the map  $T$  does not depend on  $k_t$  hence  $T$  is a *triangular map*. (About triangular maps see, e.g., Gardini and Mira [8], Kolyada [9], and Kolyada and Sharkovskii [10].) This means that the dynamics of the fraction of corrupt firms are only affected by the fraction itself; as a consequence, the one-dimensional system (3.2) is the *driving system* while the capital percapita evolution is *driven* by the dynamics of corrupt firms.

The equilibrium points (or steady states) of map  $T$  are the solutions of the algebraic system  $T_1(m, k) = (m, k)$  if and only if  $m < 1$  and of  $T_2(m, k) = (m, k)$  if and only if  $m \geq 1$ .

In order to determine the number of fixed points of  $T$  and their local stability, consider the first equation of map  $T$ . Function  $g$  is a continuous map presenting a unique non-differentiable point  $P_1 = (1, \mu\Delta c / (1-\mu))$ ; furthermore, in any open neighborhood  $U$  of  $m_t = 1$  the map  $g$  is constant on the right component of  $U - \{1\}$  and nonlinear on the other.

Simple geometrical considerations enable us to observe that  $g$  has at least one fixed point for any choice of the parameter values (being  $\lim_{m_t \rightarrow 0^+} g_1 = +\infty$  and  $\lim_{m_t \rightarrow +\infty} g_2 = L$ ).

It is important to stress that, in our model, the possible scenarios for the long term depend on the parameters that determine the expedience of corruption: the differential costs ( $\Delta c$ ), the growth rate of the marginal costs of monitoring ( $\alpha$ ) that influence its level and availability of public resources to reduce corruption ( $1 - \mu$ ). Whatever the parameters considered in our model, there is always at least one equilibrium. Observe also that no long-run equilibria with zero corruption are possible. This fact derives from the assumption about the monitoring function  $\omega$ : the equilibrium with no corruption is not a steady state because if corruption were zero, then the corresponding monitoring level would be zero, and all i-type firms would find it worthwhile to be corrupt.

Regarding the number of fixed points of the one-dimensional map  $g$  and some preliminary results on their stability, the following proposition holds.

**Proposition 3.1.** *Consider the one-dimensional map  $g$  given by (3.2).*

(a) *Let  $\mu \leq 1/\alpha$ . Then,*

- (a.1) *if  $\Delta c > (1 - \mu)/\mu$ ,  $g$  has a unique fixed point  $m^* = m_c = \mu\Delta c / (1 - \mu) > 1$ , that is, globally asymptotically stable;*
- (a.2) *if  $\Delta c = (1 - \mu)/\mu$ ,  $g$  has a unique fixed point  $m^* = m_c = 1$ , that is, globally asymptotically stable;*
- (a.3) *if  $\Delta c < (1 - \mu)/\mu$ ,  $g$  has a unique fixed point  $m^* = \bar{m} < 1$  that may be stable or unstable; a two period cycle may be present.*

(b) *Let  $\mu > 1/\alpha$ . Then,*

- (b.1) *if  $\Delta c < (1 - \mu)/\mu$ ,  $g$  has a unique fixed point  $m^* = \bar{m} < 1$  that may be stable or unstable, and complex dynamics can be exhibited;*
- (b.2) *if  $\Delta c = (1 - \mu)/\mu$  two cases may occur:*
  - (b.2.1) *if  $\alpha \leq \Delta c / (\Delta c + 1) + \Delta c + 1$ ,  $g$  has a unique fixed point  $m^* = m_c = 1$ , that is, globally asymptotically stable,*
  - (b.2.2) *if  $\alpha > \Delta c / (\Delta c + 1) + \Delta c + 1$ ,  $g$  has two fixed points  $m_1^* = \bar{m} < m_2^* = m_c = 1$  such that  $m_c$  attracts all trajectories starting from an initial condition (i.c.)  $m_0 \geq 1$  while  $\bar{m} < 1$  may be stable or unstable and complex dynamics can be exhibited;*
- (b.3) *if  $\Delta c > (1 - \mu)/\mu$ , two cases may occur:*
  - (b.3.1) *if  $\alpha \leq \Delta c / (\Delta c + 1) + \Delta c + 1$ ,  $g$  has a unique fixed point  $m^* = m_c = \mu\Delta c / (1 - \mu) > 1$ , that is, globally asymptotically stable,*
  - (b.3.2) *if  $\alpha > \Delta c / (\Delta c + 1) + \Delta c + 1$ , then a  $\bar{\Delta c}$  does exist such that (i) if  $\Delta c > \bar{\Delta c}$ ,  $g$  has a unique fixed point  $m^* = \bar{m}_c = \mu\Delta c / (1 - \mu) > 1$ , that is, globally asymptotically stable; (ii) if  $\Delta c = \bar{\Delta c}$  a fold bifurcation occurs such that  $g$  has two fixed points  $m_1^* = \bar{m} < 1 < m_2^* = m_c$ , furthermore  $\bar{m}$  is unstable while  $m_c$  is locally asymptotically stable; (iii) if  $\Delta c < \bar{\Delta c}$ ,  $g$  has three fixed points*

$m_1^* = \bar{m} < m_2^* = \bar{m}_1 < 1 < m_3^* = m_c$  such that  $m_c$  is locally asymptotically stable,  $\bar{m}_1$  is unstable while  $\bar{m}$  may be stable or unstable and complex dynamics can be exhibited.

*Proof.* Consider first that  $g_1(m_t) = \Delta c/\omega(m_t) - \Delta c$ , hence  $g_1'(m_t) = -(\Delta c/[\omega(m_t)]^2)\omega'(m_t)$ . As a consequence  $\tilde{m}_t = (\mu\alpha)^{1/(1-\alpha)}$  is a minimum point of  $g$  if and only if  $\tilde{m}_t < 1$ , that is,  $\mu > 1/\alpha$  (otherwise map  $g$  is monotonically decreasing).

- (a) Assume that  $\mu \leq 1/\alpha$  so that  $g$  is monotonically decreasing. Being  $\lim_{m_t^* \rightarrow 0^+} g_1 = +\infty$  and  $\lim_{m_t^* \rightarrow +\infty} g_2 = L$  a unique fixed point exists. Trivially, if  $\Delta c \geq (1-\mu)/\mu$  then  $g_2(1) \geq 1$ , and the fixed point  $m_c = \Delta c\mu/(1-\mu) > 1$  does exist; it is globally asymptotically stable for  $g$  being  $g_2'(m_c) = 0$ . Observe that a border collision bifurcation occurs if  $\Delta c = (1-\mu)/\mu$ , being  $m_c = 1$ . Otherwise, if  $\Delta c < (1-\mu)/\mu$  the fixed point is given by  $\bar{m} < 1$ . Since  $g_1'(\bar{m}) < 0$ , then  $\bar{m}$  can be stable or unstable, and a two-period cycle may be created via flip bifurcation if  $g_1'(\bar{m}) = -1$ . No complex dynamics can be exhibited.
- (b) Assume that  $\mu > 1/\alpha$  so that  $g$  is unimodal and the point  $P_{\min} = (\tilde{m}, g(\tilde{m})) = ((\mu\alpha)^{1/(1-\alpha)}, \Delta c/(\mu\alpha)^{\alpha/(1-\alpha)}(\mu\alpha - \mu) - \Delta c)$  is the unique minimum point of  $g$ . If  $\Delta c < (1-\mu)/\mu$  the point  $P_1 = (1, g(1))$  is below the main diagonal hence a unique fixed point  $\bar{m} < 1$  exists; it can be stable or unstable, and complex dynamics can be exhibited. If  $\Delta c = (1-\mu)/\mu$  a border collision bifurcation occurs such that  $m_c = 1$  becomes fixed point. In such a case another fixed point  $\bar{m} < 1$  exists if and only if  $\lim_{m_t \rightarrow 1^-} g'(m_t) > 1$ , that is,  $\alpha > \Delta c/(\Delta c + 1) + \Delta c + 1$ ;  $\bar{m}$  can be stable or unstable and complex dynamics can be exhibited. Finally, if  $\Delta c > (1-\mu)/\mu$  the point  $P_1 = (1, g(1))$  is above the main diagonal, hence  $m_c = \Delta c\mu/(1-\mu)$  is a locally asymptotically stable fixed point. Consider what happens in the limiting cases: if  $\Delta c \rightarrow +\infty$  then  $g_1(m_{\min}) \rightarrow +\infty$  (where  $g_1(m_{\min})$  is increasing with respect to  $\Delta c$ ), if  $\Delta c \rightarrow (1-\mu)/\mu$  we get into the case (b.2). Consequently, if  $\alpha \leq \Delta c/(\Delta c + 1) + \Delta c + 1$ ,  $g$  has a unique fixed point  $m^* = m_c = \mu\Delta c/(1-\mu) > 1$ , that is, globally asymptotically stable (since this holds in the limiting case  $\Delta c \rightarrow (1-\mu)/\mu$ ). While, if  $\alpha < \Delta c/(\Delta c + 1) + \Delta c + 1$ , a  $\bar{\Delta c}$  does exist such that if  $\Delta c = \bar{\Delta c}$  a fold bifurcation occurs. Two more fixed points are created that are given by  $m_1^* = \bar{m} < m_2^* = \bar{m}_1$ , then  $\bar{m}_1$  is always unstable while  $\bar{m}$  can be stable or unstable and complex dynamics can be exhibited.  $\square$

All the above-mentioned cases are presented in Figure 1.

Let  $m^*$  be a fixed point of map  $g$ . From the second equation we have that the associated  $k$ -values are the fixed points of the one-dimensional map  $f(m^*, k)$ .

Assume that  $m^* < 1$ , then equation  $f_1(m^*, k) = k$  has two solutions given by

$$k_{01} = 0, \quad k_{11} = \left[ \frac{s}{n + \delta} (A_h - m^* \Delta A) \right]^{1/(1-\rho)} > 0; \quad (3.4)$$

otherwise, if  $m^* \geq 1$  we obtain a similar result, that is,  $f_2(m^*, k) = k$  if and only if

$$k_{02} = 0 \quad \text{or} \quad k_{12} = \left[ \frac{sA_l}{n + \delta} \right]^{1/(1-\rho)} > 0. \quad (3.5)$$

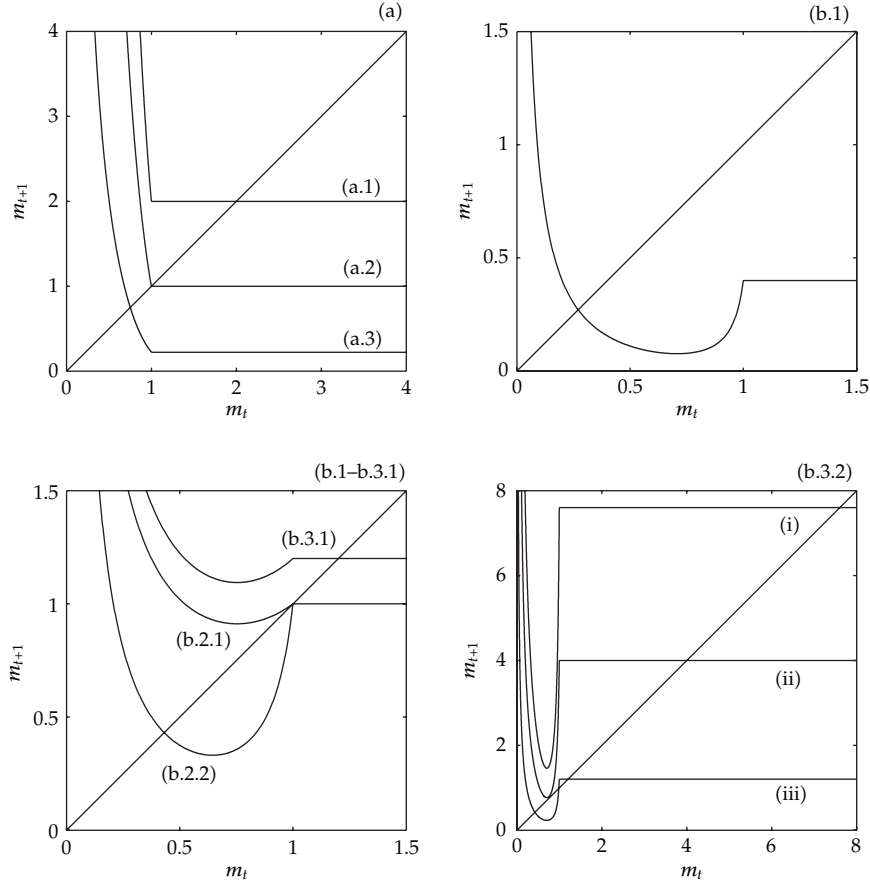

**Figure 1:** Fixed points of map  $g$  as stated in cases of Proposition 3.1. In case (a)  $\mu = 0.1, \alpha = 5$  while  $\Delta c = 18$  in (a.1),  $\Delta c = 9$  in (a.2),  $\Delta c = 2$  in (a.3). In case (b.1)  $\mu = 0.8, \alpha = 5$  while  $\Delta c = 0.1$ . In case (b.2) and (b.3.1),  $\mu = 0.8, \Delta c = 0.25$  while  $\alpha = 1.4$  in (b.2.1),  $\alpha = 3$  in (b.2.2),  $\alpha = 1.4$  and  $\Delta c = 0.3$  in (b.3.1). In case (b.3.2)  $\mu = 0.8, \alpha = 5$  while  $\Delta c = 1.8$  in (i),  $\Delta c = 1$  in (ii), and  $\Delta c = 0.3$  in (iii).

Hence, two solutions of equation  $f(m^*, k) = k$  correspond to any fixed point of  $g$  and consequently, by taking into account Proposition 3.1, system  $T$  has up to six fixed points depending on the parameter values of the model. As a consequence, multiple equilibria occur, corresponding to different long-run economic growth paths associated with the presence of corruption.

Let  $P^* = (m^*, k^*)$  be a generic fixed point of system  $T$  such that  $m^* \neq 1$ . For its local stability analysis we denote with  $J_1(m, k)$  the Jacobian matrix of the system  $T_1$  and with  $J_2(m, k)$  the jacobian matrix of the system  $T_2$ . We recall the following property.

*Property 1.* The eigenvalues of  $J_1(m^*, k^*), (J_2(m^*, k^*))$  are always real, given by  $\lambda_1 = g'_1(m^*)$  and  $\lambda_2 = (\partial f_1 / \partial k)(m^*, k^*) (\nu_1 = g'_2(m^*)$  and  $\nu_2 = (\partial f_2 / \partial k)(m^*, k^*)$ ). Any fixed point of  $T$  such that  $m^* \neq 1$  is therefore either a node or a saddle.

The local stability analysis of the fixed points can be carried out by studying the localization of the eigenvalues of the jacobian matrixes in the complex plane, and it is well

known that a sufficient condition for the local stability is that both the eigenvalues are inside the unit circle. The triangular structure of system  $T$  simplifies our analysis, since, according to Property 1, the jacobian matrixes of  $T$  have real eigenvalues located on the main diagonal, given by

$$\lambda_1(m^*) = \frac{-\Delta c [1 - \mu \alpha (m^*)^{\alpha-1}]}{[m^* - \mu (m^*)^\alpha]^2}, \quad (3.6)$$

$$\lambda_2(m^*, k^*) = \frac{1}{1+n} [s \rho (k^*)^{\rho-1} (A_h - m^* \Delta A) + 1 - \delta]$$

if  $P^* \in R_1$  and

$$\begin{aligned} v_1(m^*) &= 0, \\ v_2(m^*, k^*) &= \frac{1}{1+n} [s A_l \rho (k^*)^{\rho-1} + 1 - \delta] \end{aligned} \quad (3.7)$$

if  $P^* \in R_2$ .

Observe that all the fixed points belonging to the region  $R_1$  are of the kind  $(m^*, 0)$  or  $(m^*, k_{11})$ . Moreover  $\lim_{k \rightarrow 0^+} \lambda_2(m^*, k) = +\infty$ , and

$$\lambda_2(m^*, k_{11}) = \frac{1}{1+n} [\rho(n + \delta) + (1 - \delta)] \in (0, 1) \quad (3.8)$$

so that fixed points belonging to the line  $k_t = 0$  can be both saddle points or unstable nodes while fixed points belonging to  $k_t = k_{11}$  can be both saddle points or stable nodes.

Similarly, if  $m^* = m_c > 1$ ,  $v_1(m^*) = 0$ . Also in this case we have  $\lim_{k \rightarrow 0^+} v_2(m^*, k) = +\infty$ , and it is possible to see that  $v_2(m^*, k_{12}) = \lambda_2(m^*, k_{11}) \in (0, 1)$ , so that fixed points  $(m_c, 0)$  are saddle points, while fixed points  $(m_c, k_{12})$  are stable nodes.

In order to consider the stability of the fixed points and the bifurcations they undergo as some parameters vary, in what follows we study the system  $T$  restricted to  $k \neq 0$ , according to the following considerations. First of all, all the steady states characterized by zero capital per capita have no economic significance; secondly the set  $k = 0$  is repelling.

Observe that Proposition 3.1 states conditions such that our model admits a fixed point in which all i-type firms are corrupt. In fact, for any given value of  $\mu$ , a  $\Delta c$  exists such that if  $\Delta c$  is great enough, that is,  $\Delta c \geq (1 - \mu)/\mu$ ,  $M_c = (m_c, k_{12})$  is a steady state. Previous condition is verified if, given the budget constraint, the State cannot guarantee a sufficiently high monitoring level to reduce corruption, being the difference between costs of producing a high-quality level and a low-quality level public good, too high. Furthermore  $M_c$  is a stable node, hence, for any i.c.  $(m_0, k_0) \in I(M_c, r)$  the system will converge to  $M_c$ . Notice that the State can only use the amount of public resources used to monitor public procurement as an instrument to reduce the corruption level. Thus, in this situation, the State may seek to remove the expedience of corruption, using more public funds in the fight against corruption. The low use of resources allocated for that purpose may lead the economy into a *corruption trap* with all the corrupt firms and low-growth trap from which the economic system fails to exit.

Furthermore, if  $\mu \leq 1/\alpha$  such a fixed point is unique so that it is globally stable. Differently, if  $\mu > 1/\alpha$ , equilibria with low, intermediate, or high corruption (eventually coexisting) can be owned. They can be stable nodes or saddle points, and complicated dynamics can arise.

### 3.1. Local Bifurcations

In order to consider the qualitative dynamics of the two-dimensional system  $T$  and some local bifurcations, we first focus on the case (a) of Proposition 3.1 in which  $\mu \leq 1/\alpha$ . In such a case function  $g$  monotonically decreases, and system  $T$  admits only one fixed point which is a border crossing fixed point since, as some parameters vary, it passes from  $R_1$  to  $R_2$ . Regarding its stability, recall Proposition 3.1, then if  $\Delta c > (1 - \mu)/\mu$  the fixed point  $M_c = (m_c, k_{12}) \in R_2$  is a stable node, while, if  $\Delta c = (1 - \mu)/\mu$  the fixed point collides with the border separating  $R_1$  and  $R_2$ ; anyway it is still a stable node. On the contrary, if  $\Delta c < (1 - \mu)/\mu$ , that is,  $\mu\Delta c/(1 - \mu) \in (0, 1)$ , the fixed point  $M = (\bar{m}, k_{11}) \in R_1$  is such that  $\lambda_1(\bar{m}) < 0$  hence it can be both a stable node or a saddle point, and a 2-period cycle may be created via flip or border collision bifurcation. More in detail, observe that

- (i) if  $\mu\Delta c/(1 - \mu) \rightarrow 1$ , then  $\bar{m} \rightarrow 1$  and  $g'_1(1) \rightarrow -\Delta c(1 - \mu\alpha)/(1 - \mu)^2 = L < 0$ ;
- (ii) if  $\mu\Delta c/(1 - \mu) \rightarrow 0$ , then  $\bar{m} \rightarrow 0$  and  $g'_1(\bar{m}) \rightarrow -\infty$ ;
- (iii)  $g'_1(\bar{m})$  is increasing with respect to  $\bar{m}$ .

As a consequence, two cases may occur.

- (1) If  $L < -1$  then a border collision bifurcation occurs at the border crossing fixed point. In fact for  $\mu\Delta c/(1 - \mu) > 1$  there is an attracting fixed point  $M_c$  (whose orbit index is +1), for  $\mu\Delta c/(1 - \mu) < 1$  there are a flip saddle (on such a kind of bifurcation see [11])  $M$  with eigenvalues  $\lambda_1 < -1$  and  $0 < \lambda_2 < 1$  (whose orbit index is 0) and a period 2 attractor (with orbit index +1); about the concept of orbit index see Nusse and Yorke [12]. Finally, observe that at  $\mu\Delta c/(1 - \mu) = 1$  the fixed point collides with the border. In other words, a border collision bifurcation does occur since the orbit index of the fixed point before the collision with the border is different from the orbit index of the fixed point after the collision (see again [12]).
- (2) If  $L \in (-1, 0)$  then the fixed point  $M$  loses stability via flip bifurcation (a 2-period cycle is created for map  $g$  that is asymptotically stable).

Observe that, being the second component of our system  $T$  strictly increasing with respect to  $k$ , in all the above-mentioned cases no complex dynamics can emerge.

From the economic point of view, we observe that, if  $\mu$  is low enough, the budget constraint for the State in monitoring corruption is not so strict, and the State may always increase its control activity as corruption increases. However, two different cases may occur. If  $\mu \geq 1/(1 + \Delta c)$  the monitoring activity is not able to reduce corruption since the difference between the production costs is high and, consequently, all firms are corrupt. Hence the system will converge in the long run to a steady state with total corruption and with economic growth at the minimum level (that which can be reached with low-quality production input). If  $\mu < 1/(1 + \Delta c)$  the State can reduce corruption as it is only worth a fraction  $m^* < 1$  of  $i$ -type firms' while to be corrupted: in such a case the difference between production costs is not so high as to make corruption worthwhile for all firms. However, simple geometrical



considerations enable us to conclude that the system may fluctuate. The fixed point may be stable or unstable; in this last case a stable cycle of period two exists but no complex dynamics is possible. Monitoring follows corruption, for example, at time  $t$ ; for example, corruption is low, hence in the following period the monitoring level will also be low so that corruption will become economically more attractive, making it grow. This, in turn, will increase monitoring again to discourage corruption: it will decrease, and the cycle begins again. As a consequence, the economic growth rate motion will also fluctuate.

Consider now case (b) of Proposition 3.1 with  $\mu > 1/\alpha$ , that is, function  $g$  is unimodal, in order to investigate complex dynamics produced by system  $T$ .

We first observe that  $g$  has a minimum point given by

$$P_{\min} = (m_{\min}, g_1(m_{\min})) = \left( (\mu\alpha)^{1/(1-\alpha)}, \frac{\Delta c}{(\mu\alpha)^{\alpha/(1-\alpha)}(\mu\alpha - \mu)} - \Delta c \right). \quad (3.9)$$

Then it is worth distinguishing the possible scenarios:  $P_{\min}$  above or below the main diagonal. Recalling Proposition 3.1, we can summarize what happens in terms of the two-dimensional system  $T$  in the first case, that is,  $m_{\min} \leq g(m_{\min})$ , as follows:

- (i) in cases (b.3.1) and (b.2.1), that is,  $\Delta c \geq (1 - \mu)/\mu$  and  $\alpha \leq \Delta c/(\Delta c + 1) + \Delta c + 1$ , the unique fixed point  $M_c$  exists, which is a stable node (and it is globally stable for any i.c. with  $k_0 \neq 0$ );
- (ii) in case (b.3.2) (i), that is,  $\Delta c > (1 - \mu)/\mu$  and  $\alpha > \Delta c/(\Delta c + 1) + \Delta c + 1$ , with  $\Delta c$  great enough, the unique fixed point  $M_c$  exists, which is a stable node;
- (iii) in case (b.3.2) (ii), that is,  $\Delta c > (1 - \mu)/\mu$  and  $\alpha > \Delta c/(\Delta c + 1) + \Delta c + 1$ , with  $\Delta c = \bar{\Delta c}$ ,  $T$  has two fixed points having positive  $k$  values: a stable node  $M_c$  and a saddle point  $M$ , created via fold bifurcation.

Notice that in the above-mentioned cases all the fixed points of  $g$  having  $m^* \neq 1$  are such that  $g'(m^*) > 0$ , hence  $(m^*, k^*)$  can be both a stable node or a saddle point but no complex dynamics can be exhibited. Consequently, in what follows we focus on the dynamics of the system when the minimum point is below the main diagonal. The following remark summarizes such a case.

*Remark 3.2.* Assume  $\mu > 1/\alpha$ ,  $k \neq 0$  and  $m_{\min} > g(m_{\min})$ , that is,

$$(\mu\alpha)^{1/(1-\alpha)} + \Delta c > \frac{\Delta c}{(\mu\alpha)^{\alpha/(1-\alpha)}(\mu\alpha - \mu)}, \quad (3.10)$$

hence

- (i) if  $\Delta c < (1 - \mu)/\mu$ ,  $T$  has one fixed point  $M = (\bar{m}, k_{11})$ ;
- (ii) if  $\Delta c = (1 - \mu)/\mu$ ,  $T$  has two fixed points  $M = (\bar{m}, k_{11})$  and  $(1, k_{12})$ ;
- (iii) if  $\Delta c > (1 - \mu)/\mu$ ,  $T$  has three fixed points:  $M = (\bar{m}, k_{11})$ ,  $(\bar{m}_1, k_{11})$  (which is a saddle since  $\lambda_1(\bar{m}_1) > 1$ ) and  $M_c = (m_c, k_{12})$  (which is a stable node).

Observe that  $T$  has at most one fixed point having a negative eigenvalue given by  $M$ , which can be a stable node. In this case, the only way it loses stability is via period-doubling bifurcation. This result is rigorously proved in the following proposition.

**Proposition 3.3.** Let  $M = (\bar{m}, k_{11})$  be the fixed point of the system  $T$  with  $\bar{m} < (\mu\alpha)^{1/(1-\alpha)}$ . For each  $(\alpha, \mu)$  in the region defined as

$$\Omega_1(\bar{m}) = \left\{ (\alpha, \mu) : \mu > \frac{\Delta c^2}{(\alpha - 1)\bar{m}^\alpha(\bar{m} + \Delta c)^2} \right\}. \quad (3.11)$$

$M$  is a stable node. Outside this region, it is a saddle.

*Proof.* We recall that the eigenvalues of the Jacobian evaluated at the fixed point  $(\bar{m}, k_{11})$  are  $\lambda_1(\bar{m})$  and  $\lambda_2(\bar{m}, k_{11})$  with  $0 < \lambda_2 < 1$ . As a consequence, we look at  $\lambda_1(\bar{m})$ .

Notice that  $-\Delta c[1 - \mu\alpha(\bar{m})^{\alpha-1}] < 0$  (i.e.,  $\lambda_1(\bar{m}) < 0$ ) is always satisfied under the assumption  $\bar{m} < (\mu\alpha)^{1/(1-\alpha)}$ . This means that  $|\lambda_1(\bar{m})| < 1$  if and only if  $\lambda_1(\bar{m}) > -1$ , that is,

$$\lambda_1(\bar{m}) = \frac{-\Delta c[1 - \mu\alpha(\bar{m})^{\alpha-1}]}{[\bar{m} - \mu\bar{m}^\alpha]^2} > -1. \quad (3.12)$$

The last condition can be rewritten as

$$\Delta c(\bar{m} - \mu\bar{m}^\alpha) + \Delta c\mu\bar{m}^\alpha(1 - \alpha) - \bar{m}(\bar{m} - \mu\bar{m}^\alpha)^2 < 0. \quad (3.13)$$

We already know that the equation  $\bar{m} = \Delta c / (\bar{m} - \mu\bar{m}^\alpha) - \Delta c$ , that is,  $\bar{m} - \mu\bar{m}^\alpha = \Delta c / (\bar{m} + \Delta c)$ , implicitly defines the corruption equilibrium level  $\bar{m}$ , so that condition (3.13) can be rewritten as

$$\mu > \frac{\Delta c^2}{(\alpha - 1)\bar{m}^\alpha(\bar{m} + \Delta c)^2}. \quad (3.14)$$

□

From Proposition 3.3, it follows that the only way the equilibrium  $M$  can lose stability is through a flip (or period doubling) bifurcation, where the stable fixed point becomes unstable (a saddle) giving rise to a 2-period stable cycle  $C_2$ . The determination of the flip-bifurcation curve  $S_1$

$$\mu = \frac{\Delta c^2}{(\alpha - 1)\bar{m}^\alpha(\bar{m} + \Delta c)^2} \quad (3.15)$$

in the parameters' plane  $(\alpha, \mu)$  can only be done through numerical evaluation.

The following proposition states a sufficient condition on the parameters for the existence of a stable 2-period cycle  $\{(m_1, k_1), (m_2, k_2)\}$  such that  $(m_i, k_i) \in R_i$ ,  $(i = 1, 2)$ .

**Proposition 3.4.** Let  $\Delta c < (1 - \mu)/\mu$ . For each  $(\alpha, \mu)$  in the region defined as

$$\Omega_2 = \left\{ (\alpha, \mu) : \frac{\Delta c}{m_1 - \mu m_1^\alpha} - \Delta c \geq 1 \right\}, \quad (3.16)$$

the system  $T$  admits a stable 2-period cycle defined as  $C'_2 = \{(m_1, k_1), (m_2, k_2)\}$  with  $m_1 = \mu\Delta c / (1 - \mu)$ ,  $m_2 = g_1(m_1)$  and  $k_i$  such that  $k_i = f_i(m_i, k_i)$  ( $i = 1, 2$ ).

*Proof.* A 2-cycle for  $g(m)$  must be of the form  $\{m_1, m_2\}$  with  $g_1(m_1) = m_2$  and  $g_2(m_2) = m_1$ . We observe that  $m_1 = \mu\Delta c / (1 - \mu) < 1$  (under the assumption  $\Delta c < (1 - \mu) / \mu$ ), hence  $m_2 = g(m_1) = g_1(m_1)$ . As a consequence, if  $m_2 \geq 1$  then  $g(m_2) = g_2(m_2) = m_1$ . Consequently, the map  $g(m)$  admits a 2-period cycle  $\{m_1, m_2\}$  defined by  $m_1 = \mu\Delta c / (1 - \mu)$  and  $m_2 = g_1(m_1)$ .

Condition  $m_2 = g_1(m_1) \geq 1$  is given by

$$\frac{\Delta c}{m_1 - \mu m_1^\alpha} - \Delta c \geq 1. \quad (3.17)$$

This implies the existence of a 2-period cycle of the system  $T$  defined as  $C'_2 = \{(m_1, k_1), (m_2, k_2)\}$  with  $k_1 = f_1(m_1, k_1)$  and  $k_2 = f_2(m_2, k_2)$ , and condition  $g_1(m_1) = m_2 = 1$  is the border collision bifurcation curve leading to the existence of such cycle.

Finally, the eigenvalues of the 2-cycle (i.e., the eigenvalues of the jacobian matrix of  $T^2$  in any point of the cycle) are given by  $z_1 = g'_1(m_1)g'_2(m_2)$  and  $z_2 = (\partial f_1 / \partial k)(m_1, k_1)(\partial f_2 / \partial k)(m_2, k_2)$ . Recalling that  $g'_2(m) = 0$  for all  $m$  (hence  $z_1 = 0$ ) and that a stable 2-cycle for  $g$  generates a stable 2-cycle for  $T$  (since  $f$  is strictly increasing with respect to  $k$ ), our statement is proved.  $\square$

From Proposition 3.4 it immediately follows that the curve  $S_2$  defined in the parameters' plane  $(\alpha, \mu)$  as  $\Delta c / (m_1 - \mu m_1^\alpha) - \Delta c = 1$  is the boundary of the region  $\Omega_2$ , where the existence of the 2-period cycle  $C'_2$  of  $T$  is guaranteed.

In Figure 2 we consider the parameters' plane  $(\alpha, \mu)$  and summarize the main results related to cases (a) and (b) (the set of points below and above the curve  $\mu\alpha = 1$ , resp.). More precisely, we present different regions such that the trajectory starting from the initial condition  $(m_{\min}, k_0)$  having  $k_0 > 0$  converges to a fixed point,  $M_c$  or  $M$ , to a two-period cycle,  $C_2$  or  $C'_2$ , or to a more complex attractor (CD). The curves  $S_1$  and  $S_2$  are obtained by numerical evaluation of the ones defined in Propositions 3.3 and 3.4.

## 4. Global Dynamics

In this section we prove some general results concerning the global dynamics of system  $T$  in the more interesting case:  $\alpha\mu > 1$  and  $(\mu\alpha)^{1/(1-\alpha)} + \Delta c > \Delta c / (\mu\alpha)^{\alpha/(1-\alpha)}(\mu\alpha - \mu)$ , that is, the one-dimensional map  $g$  admits the minimum point  $P_{\min}$  below the main diagonal. In particular, we first prove the existence of the compact global attractor, and, then, we describe its structure. Recall the following definition of the global attractor.

*Definition 4.1.* A nonempty compact set  $K$  is the global attractor of the dynamical system  $T$  if the following conditions are fulfilled:

- (1)  $K$  is invariant with respect to  $T$ ;
- (2)  $K$  attracts all the bounded subsets from  $R_2^+$ .

We recall that a set  $K$  is invariant if  $T(K) = K$ .

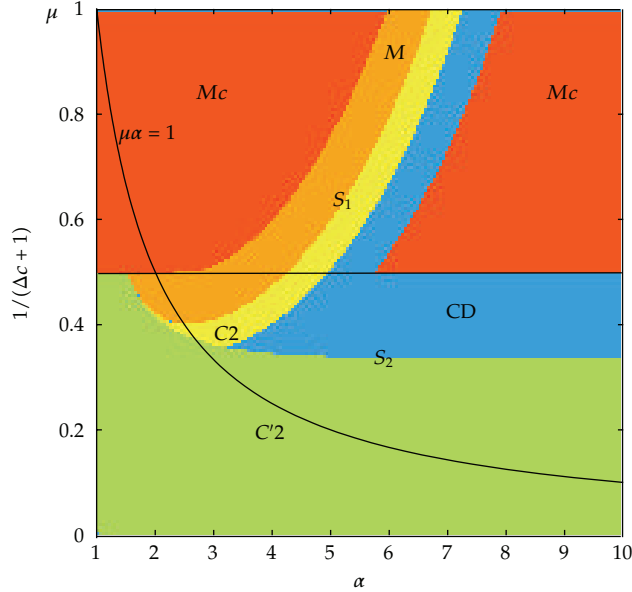

**Figure 2:** Region of local stability of the fixed points and of the two-period cycles in the parameters' plane  $(\alpha, \mu)$  being  $n = 1.1$ ,  $\delta = 0.5\Delta c = 1$ ,  $s = 0.3$ ,  $\rho = 0.3$ , and  $\Delta A = 0.1$  and the initial condition  $m_0 = m_{\min}$  and  $k_0 > 0$ . In region  $Mc$  the fixed point  $M_c$  is a stable node; in region  $M$  the fixed point  $M$  is a stable node; in region  $C2$  the two-period cycle  $C_2$  is stable; in region  $C'2$  the two-period cycle  $C'_2$  is stable while in  $CD$  more complex dynamics can be exhibited.

Firstly, we prove the existence of a trapping region, that is, a closed and positively invariant region, for the one-dimensional map  $g$ . Afterwards, we give conditions for the existence of the compact global attractor for the two-dimensional system  $T$ .

The following proposition states the existence of a trapping set for the map  $g$  when it admits the minimum point  $m_{\min}$  (i.e.,  $\alpha\mu > 1$ ) with  $m_{\min} > g(m_{\min})$ .

**Proposition 4.2.** *For all  $\alpha, \mu$ , and  $\Delta c$  such that  $\alpha\mu > 1$  and  $m_{\min} > g(m_{\min})$ , the one-dimensional map  $g$  admits a trapping interval  $J$ , where  $J$  is defined as follows:*

- (1)  $J = [g_1(m_{\min}), g_1(1)]$  if  $\mu\Delta c/(1 - \mu) \geq 1$ ,
- (2)  $J = [g_1(m_{\min}), g_1^2(m_{\min})]$  if  $\mu\Delta c/(1 - \mu) < 1$ .

*Proof.* For all  $\alpha$  and  $\mu$  such that  $\alpha\mu > 1$ , the one-dimensional map  $g$  has the minimum point  $m_{\min}$ , and three different cases may occur:  $g$  has one, two, or three equilibria. Through the graphical analysis it is possible to see that when there exists a unique fixed point, that is, when  $\mu\Delta c/(1 - \mu) < 1$ ,  $J = [g_1(m_{\min}), g_1^2(m_{\min})]$  is mapped into itself by  $g$ . Otherwise, when other equilibria exist (i.e., for  $\mu\Delta c/(1 - \mu) \geq 1$ ),  $J = [g_1(m_{\min}), g_1(1)]$  is mapped into itself by  $g$ .  $\square$

The existence of the compact global attractor for the system  $T$  is proved in the following proposition.

**Proposition 4.3.** *For all  $\alpha, \mu$ , and  $\Delta c$  such that  $\alpha\mu > 1$  and  $m_{\min} > g(m_{\min})$ , the dynamic system  $T$  admits the compact global attractor  $K \subset J \times [0, k_e]$ , where  $k_e > (sA_h/(\delta + n))^{1/(1-\rho)}$  and  $J$  is defined as in Proposition 4.2.*

*Proof.* Firstly notice that Proposition 4.2 holds, and the map  $g$  admits a trapping interval  $J$ . Consequently,  $g$  admits a compact global attractor contained into  $J$ .

Let us go to consider the map  $f$ . We observe that  $\lim_{k \rightarrow +\infty} k^\rho/k = 0$  (since  $\rho \in (0, 1)$ ). This trivially means that for all  $\epsilon > 0 \exists k_\epsilon > 0$  such that  $k^\rho < \epsilon k$  for all  $k > k_\epsilon$ , consequently,

$$\begin{aligned} f_1(m, k) &= \frac{1}{1+n} [sk^\rho(A_h - m\Delta A) + (1 - \delta)k] \\ &< \frac{1}{1+n} [s\epsilon A_h + 1 - \delta]k, \end{aligned} \quad (4.1)$$

where we have made use of relation  $A_h - m\Delta A < A_h$  which holds for all  $m > 0$ .

Notice that the continuity of the map  $f = f_1 \cup f_2$  with the fact that  $f_2(m, k) = f_2(1, k)$  for all  $m \geq 1$  implies that formula (4.1) holds even if we consider function  $f_2$ . In this way we obtain

$$f(m, k) < j(k) := \frac{1}{1+n} [s\epsilon A_h + 1 - \delta]k, \quad (4.2)$$

In other words, we have proved that  $k_{t+1} < j(k_t)$  for all  $k_t > k_\epsilon$ , where  $k_\epsilon = (1/\epsilon)^{1/(1-\rho)}$ .

We now wish to prove that the generic trajectory starting from a point  $(m_0, k_0)$  at least one time intersects the set  $J \times [0, k_\epsilon]$ . To reach this goal, we suppose that the previous statement is false. Then there exists a point  $(m_0, k_0) \notin J \times [0, k_\epsilon]$  such that  $T^t(m_0, k_0) \notin J \times [0, k_\epsilon]$ , for all  $t \in \mathbb{Z}_+$ . We already know properties of the one-dimensional map  $g$ , hence it must be  $k_t = f^t(m_0, k_0) > k_\epsilon$ , for all  $t \in \mathbb{Z}_+$ . Nevertheless, assuming  $\epsilon < (\delta + n)/sA_h$ , we have

$$k_{t+1} < j(k_t) = \left( \frac{s\epsilon A_h + 1 - \delta}{1+n} \right)^t k_0 \rightarrow 0 \quad \text{as } t \rightarrow +\infty, \quad (4.3)$$

so that we obtain a contradiction.

Second, we observe that for all  $\bar{t}$  such that  $k_{\bar{t}} < k_\epsilon \Rightarrow k_{\bar{t}+1} < k_\epsilon$ . In fact, from relation  $k_{\bar{t}+1} < j(k_{\bar{t}}) = (1/(1+n))[s\epsilon A_h + 1 - \delta]k_{\bar{t}}$  it follows that  $k_{\bar{t}+1} < k_\epsilon$  since  $(1/(1+n))[s\epsilon A_h + 1 - \delta] < 1$  and  $k_{\bar{t}} < k_\epsilon$ .

Notice that  $k_\epsilon > (sA_h/(\delta + n))^{1/(1-\rho)}$  under the assumption  $\epsilon < (\delta + n)/sA_h$ , and we already know that  $k^* < (sA_h/(\delta + n))^{1/(1-\rho)}$  for all  $(m^*, k^*)$  fixed point. Since  $J \times [0, k_\epsilon]$  is a compact, positively invariant, and attracting set for  $T$ , then  $K = \bigcap_{t \geq 0} T^t(J \times [0, k_\epsilon])$  is a compact invariant set which attracts  $J \times [0, k_\epsilon]$ .  $\square$

The previous proposition enables us to observe that our growth model with corruption cannot explode since the asymptotic dynamics is always bounded, as economically plausible.

In order to investigate the structure of the attractor  $K$ , we consider the case in which hypotheses of Proposition 4.3 are fulfilled. Furthermore,  $K \subset J \times [0, k_\epsilon]$ , and, as previously underlined,  $k_t = 0$  is a repelling invariant set, hence we define the set  $D := J \times (0, k_\epsilon]$  in order to consider the restriction of the system on  $D$ , that is, the subsystem  $(T, D)$ .

By taking into account the previous considerations on the invariant set  $k_t = 0$  of  $T$  and also considering the arguments used to prove Proposition 4.3, it is easy to conclude as in the following proposition.

**Proposition 4.4.** *For any initial condition  $(m_0, k_0) \in D$ , all the images  $T^t(m_0, k_0)$  of any rank  $t$  belong to the set  $D$ .*

Given the triangular structure of our system, the dynamics of  $T$  is closely related to the one of the one-dimensional map  $g$ , as stated in the following property (see [8, 9] for a wider discussion).

*Property 2.* If  $O_n = \{m_1, m_2, \dots, m_n\}$  is an  $n$ -cycle of the map  $g$ , then the restriction of the map  $T^n$  to any vertical lines  $m = m_i, i = 1, \dots, n$ , is trapping on that line. If the  $n$ -cycle of  $g$  is attracting (resp., repelling) then the vertical lines  $m = m_i, i = 1, \dots, n$ , are attracting (resp., repelling) for  $T^n$ .

From the previous property, it trivially follows that any bifurcation of the one-dimensional map  $g$  gives rise to a bifurcation of system  $T$ . In particular, a fold bifurcation of  $g$  creates a couple of cyclical trapping lines of  $T$  (one repelling and one attracting). After a flip bifurcation of a cycle of  $g$ , trapping cyclical vertical lines (of  $T$ ) from attracting become repelling, and new cyclical attracting lines are created. Furthermore, as  $f(m_i, k)$  is strictly increasing with respect to  $k$ , if  $O_n$  is an  $n$ -period cycle for  $g$ , then system  $T$  has an  $n$ -period cycle as well. In any case, as argued at the end of the previous section, if  $g$  exhibits complex dynamics, the attractor of  $T$  may consist of a complicated set.

## 5. Complex Dynamics and Simulations

In this section, we describe the local and global bifurcations which increase the complexity of the asymptotic dynamic behaviour of the system. As we pointed out, the bifurcations and the dynamic behaviour of the two-dimensional map  $T$  can be completely described on the basis of those of the one-dimensional map  $g$ , hence we focus on the case in which  $g$  is noninvertible so that our growth model can produce cyclical fluctuations or even chaotic dynamics; furthermore, as our map is non-differentiable along the line  $m_t = 1$ , border collision bifurcations may occur. This noncanonical bifurcations have been mainly studied in the context of piecewise linear maps. Hommes and Nusse [13] showed, for instance, that a “period three to period two” bifurcation occurs for a class of piecewise linear maps. More recently, Nusse and Yorke [14] have conducted a deeper analysis of these bifurcations and described the very rich dynamics arising from them. The fact that the rich dynamics which can emerge in our model are strictly related to the analytical properties of map  $g$  is not only a consequence of the triangular structure of system  $T$ , but is also due to the fact that the second component of  $T$  is strictly increasing with respect to  $k_t$ .

The main purpose of this section is to describe the route to chaos of system  $T$ . As previously underlined,  $n$ -period cycle having  $n > 2$  or more complex features may be exhibited by our model if and only if Remark 3.2 is applied (i.e.,  $g$  has a minimum point below the main diagonal). In order to describe the complicated behaviour of the economic system, it is worth distinguishing between two different cases. Recall Proposition 4.2, and assume that  $\mu \geq 1/(\Delta c + 1)$  see again Figure 1 panel (b.3.2 case (iii)), then every initial condition generates bounded trajectories converging to an attractor included in the trapping interval  $J_1 = [g_1(m_{\min}), g_1(1)]$ , where  $g_1(m_{\min}) = \Delta c / (\mu\alpha)^{\alpha/(1-\alpha)} (\mu\alpha - \mu) - \Delta c$  is the minimum value of  $g$  (critical point of rank-1) and  $g_1(1)$  is the maximum value. Observe that, given the qualitative shape of  $g$ , we can have coexistence of attractors, as stated in the following proposition. The proof of this proposition is trivial, see Figure 3.

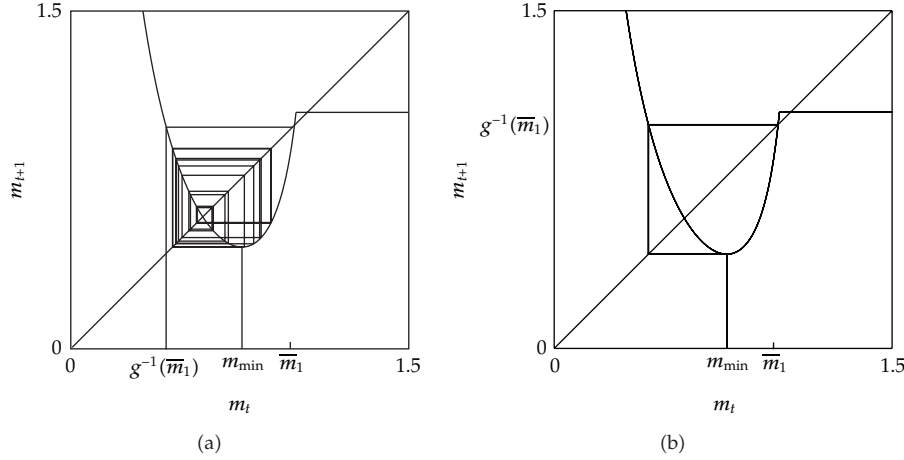

**Figure 3:** Coexistence of the attractors  $K_1$  and  $K_2$ , their basins, and the final bifurcation as  $\Delta c = 0.7$ ,  $\mu = 0.6$ , and  $\alpha = 5$ . (b) Contact bifurcation as  $\alpha = 5.457$ .

**Proposition 5.1.** Let  $\alpha\mu > 1$  and  $\mu \geq 1/(\Delta c + 1)$ .

- (1) If  $g^2(m_{\min}) < \bar{m}_1$ , then  $(T, D)$  has two coexistent attractors  $K_1$  and  $K_2$  such that  $K_1 \subset [g_1(m_{\min}), g_1^2(m_{\min})] \times (0, k_\epsilon]$  while  $K_2$  is the point  $M_c$ .
- (2) If  $g^2(m_{\min}) > \bar{m}_1$ , then the unique attractor of  $(T, D)$  is the point  $K_2 = M_c$ .
- (3) For  $g^2(m_{\min}) = \bar{m}_1$  a contact bifurcation occurs.

Notice that in the case of coexistence of attractors,  $K_1$  may be a strange attractor while  $K_2$  consists of a fixed point. If they both exist, we denote by  $B(K_1)$  (and  $B(K_2)$ ) their basins of attractions, that is, the set of points  $(m_0, k_0) \in D$  which generate trajectories converging to  $K_1$  (and  $K_2$ ), then

$$\begin{aligned}
 B(K_1) &= \left( g^{-1}(\bar{m}_1), \bar{m}_1 \right) \times (0, k_\epsilon], \\
 B(K_2) &= \left[ \left( 0, g^{-1}(\bar{m}_1) \right) \cup \left( \bar{m}_1, +\infty \right) \right] \times (0, k_\epsilon].
 \end{aligned} \tag{5.1}$$

Furthermore, when  $g^2(m_{\min}) = \bar{m}_1$  the critical point  $m_{\min}$  is preperiodic, proving the existence of parameter values such that the system is chaotic. In fact, no attracting cycles exist since their basins of attraction cannot contain the critical point.

When some parameters vary until  $g^2(m_{\min})$  crosses  $\bar{m}_1$ , a global bifurcation occurs, and the attractor  $K_1$  disappears. The contact bifurcation curve CB in the parameters' plane  $(\alpha, \mu)$  is presented in Figure 2. The attractor  $K_2$  becomes stable everywhere except a Cantor set with zero Lebesgue measure. As is well known, the dynamics on the invariant Cantor set can be described by symbolic dynamics. More specifically, it is equivalent to the dynamics of the chaotic shift map on the set of all one-sided symbolic sequences of 0's and 1's. This means that the dynamics on the Cantor set is also chaotic.

In order to discuss the bifurcations leading to chaos and to show the strange attractor that can be owned by  $T$  we present some numerical simulations. Hence we fix the following parameter values:  $n = 1.1$ ,  $\delta = 0.5$ ,  $s = 0.3$ ,  $\rho = 0.3$ , and  $\Delta A = 3$ . This latter assumption is



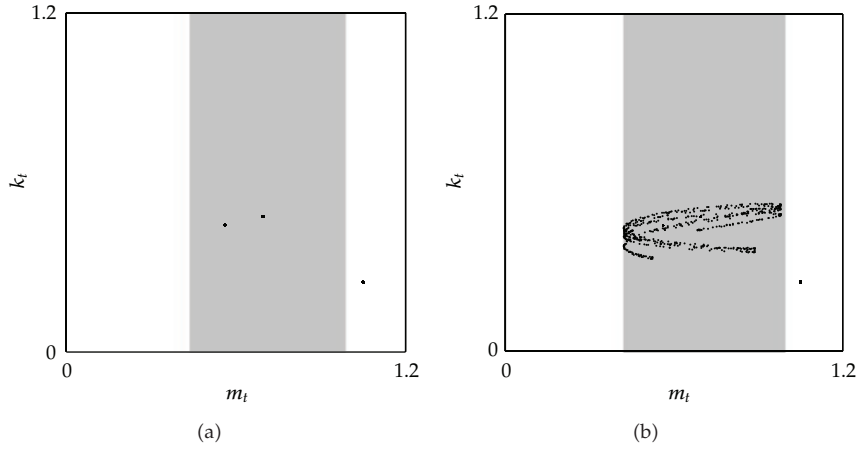

**Figure 4:** Attractor  $K_1$  and its basin (the grey region) and attractor  $K_2$  and its basin (the white region) for  $\mu = 0.6$  and  $\Delta c = 0.7$ . (a) If  $\alpha = 4K_1$  is a two-period cycle; (b) if  $\alpha = 5.4$ ,  $K_1$  is strange attractor.

without loss of generality since such parameters do not affect the final qualitative dynamics of  $T$ . On the contrary, we let parameters  $\alpha$ ,  $\mu$ , and  $\Delta c$  vary as they are responsible for complex dynamics being produced.

We now consider the case in which the hypotheses of Proposition 5.1 hold. Hence, different attractors may coexist as showed in Figure 4. The basins of attraction of the stable node  $K_2$  and of the attractor  $K_1$  are separated by the stable manifold of the saddle point  $M_1 = (\bar{m}_1, k_{11})$  which, as previously proved, is the vertical line  $m_t = \bar{m}_1$ , and by its preimage, that is, the line  $m_t = g^{-1}(\bar{m}_1)$ . Notice that the basin of  $K_2$  is composed by two regions (i.e., it is nonconnected): this means that the economic system with a low initial level of corruption may converge to the equilibrium in which all firms are corrupted as  $\mu$  is not small enough and consequently the choice of the initial conditions is crucial to decide whether economic fluctuations are obtained or not in the long run.

From the economic point of view, this situation can be presented if  $\mu$  is high enough (i.e., scarce public resources for corruption monitoring). In such a case being  $m_0$  the initial level of corruption, if  $m_0 < g^{-1}(\bar{m}_1)$  (at the initial time the corruption level in the system is low), then the State fixes a low monitoring level. At time  $t = 1$ , once the monitoring level is observed, all  $i$ -firms will find it worthwhile to be corrupted, and finally, as  $\mu$  is high, the long-run steady state will be characterized by total corruption. On the contrary, for intermediate levels of corruption at time  $t = 0$ , the corresponding monitoring level can reduce corruption and in the long run, both the fraction of corrupt firms and the economic growth would exhibit periodic or  $a$ -periodic fluctuations. However, in such a case, not all  $i$ -firms are corrupt. The equilibrium with high corruption is due to scarce public resources for controls, therefore, the State should seek to establish a value of  $\mu$  to push the system at an intermediate level of corruption in order to allow greater levels of economic growth.

Observe that the two-period cycle presented in Figure 4(a) has been created via period-doubling bifurcations at  $\alpha \approx 3.88$ : the fixed point  $M$  loses its stability and becomes a saddle, and a stable cycle of period two appears. We point out that such a local bifurcation simply replaces the stable steady state with an attracting 2-cycle, without modifying the basins of the coexisting attractors. If  $\alpha$  still increases other period doubling bifurcations occur

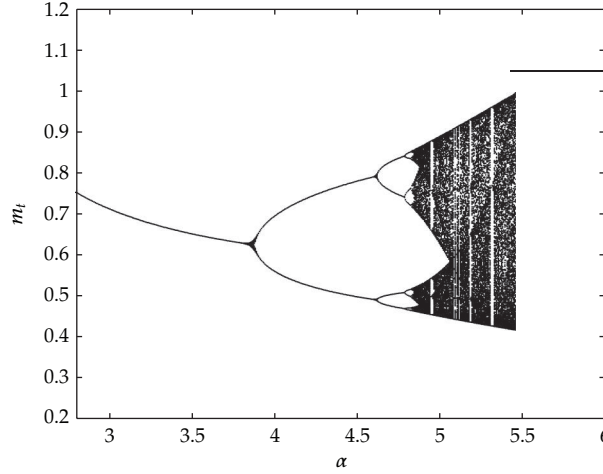

**Figure 5:** Attractor  $K_1$ : transition to complex dynamics due to a flip-bifurcation sequence for  $\mu = 0.6$  and  $\Delta c = 0.7$  and increasing values of  $\alpha$ . Contact bifurcation for  $\alpha \approx 5.458$ .

till a strange attractor is exhibited (see Figure 4(b)). The situation drastically changes at  $\alpha \approx 5.458$  where a final contact bifurcation occurs.

After this final bifurcation almost all trajectories will converge to the fixed point with total corruption and low economic growth long-run equilibrium (corruption trap).

The period-doubling route to chaos and contact bifurcation for increasing values of  $\alpha$  are presented in Figure 5. We consider as the initial value  $\alpha = 2.8$  in order to guarantee that the minimum point of function  $g$  is below the main diagonal.

Consider now the second case, that is,  $\mu < 1/(\Delta c + 1)$ , then every initial condition  $(m_0, k_0)$  generates bounded trajectories converging to the unique attractor  $K_1$  inside  $J_2 = [g_1(m_{\min}), g_1^2(m_{\min})]$ . As  $J_2$  is trapping for  $g$ , if the absorbing interval  $J_2$  of the map  $g$  is included in the interval where this map is defined by  $g_1$ , that is,

$$g^2(m_{\min}) \leq 1, \quad (5.2)$$

then only flip bifurcations are exhibited. Thus the parameter region in which condition (5.2) is satisfied has the logistic bifurcation structure (the set of points above the white curve in Figure 6). Differently the set of pairs  $(\alpha, \Delta c)$  below the white curve are such that condition (5.2) does not hold, hence the break point  $m = 1 \in J_2$  (i.e., both functions  $g_1$  and  $g_2$  are involved in the absorbing interval).

More precisely, as previously underlined the unique fixed point  $M = (\bar{m}, k_{11})$  is a stable node or a saddle point. For some parameter values, the point  $M$  is a stable node, while, as some parameters vary, it may become a saddle node. The only way it loses stability is via period-doubling bifurcation (see Proposition 3.3). After this first bifurcation, a period-doubling route to chaos occurs till a border collision bifurcation arises at  $g^2(m_{\min}) = 1$ .

In fact, the attractor of  $T$  is confined into the invariant set  $J_2 \times (0, k_e]$  hence, as long as  $1 \notin J_2$ , that is,  $g^2(m_{\min}) < 1$ , the canonical period-doubling route to chaos is exhibited, while a border collision bifurcation occurs when  $g^2(m_{\min}) = 1$ , that is, a point of the period- $n$  cycle or of the strange attractor  $K_1$  owned by  $T$  collides with the break point under the change in the parameters. Furthermore, after such a collision, the orbit index of the border-crossing cycle

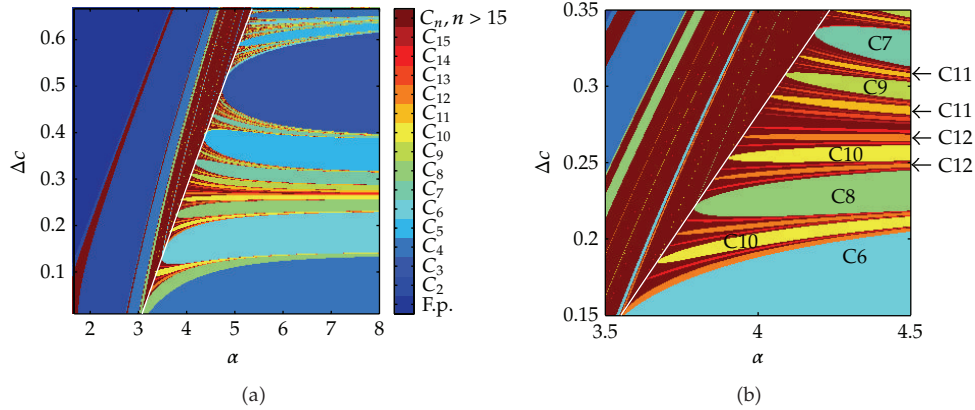

**Figure 6:** 2D bifurcation diagram of system  $T$  in the parameter plane  $(\alpha, \Delta c)$  as  $\mu = 0.6$ . The white curve is the border collision bifurcation curve. (a) We detect cycles  $C_n$  of period  $n$ ,  $n \leq 15$ . In (b) an enlargement of the previous picture.

changes so that qualitative dynamics drastically changes: a new cycle of period  $p \neq n$  can be exhibited or the final dynamics may be chaotic. Hence the economic evolution may become unpredictable (see Figure 7). In any case, it is easy to prove that the new cycle has only one point in the region  $R_2$ . The following statement summarizes our previous considerations.

**Proposition 5.2.** *If  $\alpha\mu > 1$  and  $\mu < 1/(\Delta c + 1)$ , the attractor  $K_1 \subset J_2$  is globally stable, and it may consist of a fixed point, an  $n$ -period cycle, or a strange attractor. Period-doubling bifurcations together with border collision bifurcations occur.*

Studying the map  $T$  numerically, we get an interesting two-dimensional bifurcation diagram in the plane  $(\alpha, \Delta c)$  with tongues of periodicity (we leave the study of the origin and structure of these tongues for further development). In Figure 6 we fix parameter  $\mu$  and let  $\alpha$  and  $\Delta c$  vary in a way such that hypotheses of Proposition 5.2 hold. The white curve is the border collision bifurcation curve such that a point of the  $n$ -period cycle or of the strange attractor collides with the border.

Observe also that  $g^2(\overline{m_{\min}})$  is increasing with respect to  $\alpha$  (and decreasing with respect to  $\Delta c$ ). Hence a value  $\overline{\alpha}$  ( $\overline{\Delta c}$ , resp.) may exist such that for all  $\alpha > \overline{\alpha}$  (for all  $\Delta c < \overline{\Delta c}$ , resp.) atypical bifurcations are observed. At  $\alpha = \overline{\alpha}$  ( $\Delta c = \overline{\Delta c}$ , resp.) a border collision bifurcation occurs (see Figures 7 and 8).

Our analysis proves that a rich variety of bifurcations can occur and that the attractor may be very complicated. This implies that the economic evolution can be unpredictable (as different initial conditions generate different qualitative asymptotic dynamics) and structurally unstable (as small perturbations in the parameters may generate completely different qualitative dynamics).

## 6. Conclusions and Further Development

In the present paper, starting from the discrete-time Solow growth model, we analyze the role of corruption in public procurement on long time economic growth. Our model is described by a two-dimensional dynamical system of triangular type, since one of its components

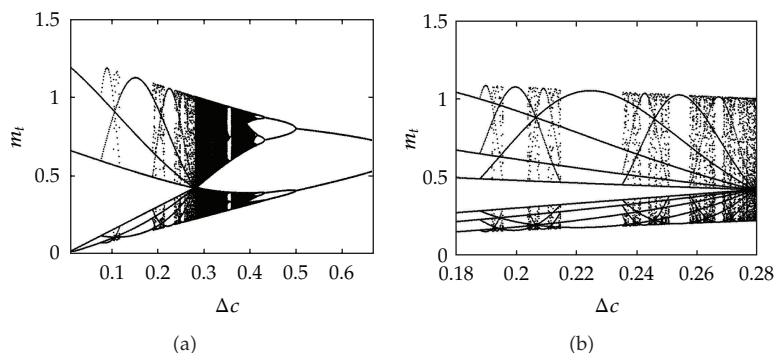

**Figure 7:** One-dimensional bifurcation diagram of map  $g$  as  $\Delta c$  varies for  $\mu = 0.6$  and  $\alpha = 4$ . Observe that  $\overline{\Delta c} = 0.2820$  and that if  $\Delta c > \overline{\Delta c}$  a period-doubling bifurcation route to chaos is exhibited. An enlargement showing the variety of period- $p$  cycles as  $\Delta c < \overline{\Delta c}$  is presented in (b).

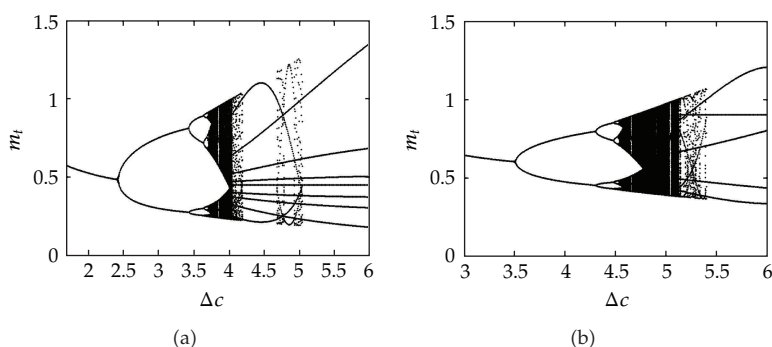

**Figure 8:** One-dimensional bifurcation diagram of map  $g$  as  $\alpha$  varies for  $\mu = 0.6$ . In (a)  $\Delta c = 0.3$  while in (b)  $\Delta c = 0.6$ . A  $\overline{\alpha}$  exists such that if  $\alpha < \overline{\alpha}$  a period-doubling bifurcation route to chaos is exhibited while at  $\alpha = \overline{\alpha}$  a border collision bifurcation occurs.

(namely, the one driving the corruption level) is an independent one-dimensional map. In addition, our map is piecewise smooth, that is, the phase space is divided into two regions in which the map is smooth.

Due to the triangular structure of the system, we have been able to explore the asymptotic dynamic behaviour and the bifurcations, starting from the study of the one-dimensional map. In particular, we have explored the dynamics of the model under different regimes of the main parameters.

An important preliminary result is that no equilibria with zero corruption can exist. Furthermore, for some parameter values, there exists a steady state with *total corruption* associated to a low-growth path, which can be globally stable, giving rise to the loss of control for the State. We have called this phenomenon corruption-trap.

We also found that the system will converge to a compact global attractor which may consist of fixed points, periodic points, or even strange attractors. As a consequence, the economic growth model may fluctuate; in such a case, it can be unpredictable and structurally unstable. Moreover, different attractors may coexist: nonconnected basins can appear, and different kind of behaviour may arise, if an exogenous perturbation moves the state of the system inside the basin of another attractor.

A variety of qualitative long-run dynamics emerge in our model depending on the parameter values. Several bifurcations are possible: the typical period-doubling bifurcation leading to chaos, some global bifurcations related to the structure of the basins of coexisting attractors, and finally, a-typical border collision bifurcations are likely to occur. In fact, for piecewise smooth maps, when a border crossing fixed point (or a border crossing orbit) collides with the border, a border collision bifurcation arises. The rich variety of bifurcations exhibited by our model implies that the qualitative dynamics can drastically change after perturbations on some parameters.

The present model is a first step in the study of the role of corruption in public procurement and of its effect on growth. An interesting development would incorporate the State balance to take into account the budget constraint explicitly (for instance, by introducing taxation to finance corruption monitoring activity).

## References

- [1] S. Rose-Ackerman, *Corruption and Government*, Cambridge University Press, Cambridge, UK, 1999.
- [2] M. Celentani and J.-J. Ganuza, "Corruption and competition in procurement," *European Economic Review*, vol. 46, no. 7, pp. 1273–1303, 2002.
- [3] R. J. Barro, "Government spending in a simple model of endogenous growth," *Journal of Political Economy*, vol. 98, pp. 103–125, 1990.
- [4] A. Del Monte and E. Papagni, "Public expenditure, corruption, and economic growth: the case of Italy," *European Journal of Political Economy*, vol. 17, no. 1, pp. 1–16, 2001.
- [5] P. Bajari and S. Tadelis, "Incentives versus transaction costs: a theory of procurement contracts," *RAND Journal of Economics*, vol. 32, no. 3, pp. 387–407, 2001.
- [6] N. Bose, S. Capasso, and A. P. Murshid, "Threshold effects of corruption: theory and evidence," *World Development*, vol. 36, no. 7, pp. 1173–1191, 2008.
- [7] R. M. Solow, "A contribution to the theory of economic growth," *Quarterly Journal of Economics*, vol. 70, pp. 65–94, 1956.
- [8] L. Gardini and C. Mira, "On the dynamics of triangular maps," *Progetto Nazionale di Ricerca M.U.R.S.T. Dinamiche non lineari e applicazioni alle scienze economiche e sociali. Quaderno no. 9305*, 1993.
- [9] S. F. Kolyada, "On dynamics of triangular maps of the square," *Ergodic Theory and Dynamical Systems*, vol. 12, no. 4, pp. 749–768, 1992.
- [10] S. F. Kolyada and A. N. Sharkovsky, "On topological dynamics of triangular maps of the plane," in *European Conference on Iteration Theory (Batschuns, 1989)*, pp. 177–183, World Scientific, Singapore, 1991.
- [11] M. Lines and A. Medio, *Nonlinear Dynamics*, Cambridge University Press, Cambridge, UK, 2001.
- [12] H. E. Nusse and J. A. Yorke, "Border-collision bifurcations including "period two to period three" for piecewise smooth systems," *Physica D*, vol. 57, no. 1-2, pp. 39–57, 1992.
- [13] C. H. Hommes and H. E. Nusse, "Period three to period two bifurcation for piecewise linear models," *Journal of Economics*, vol. 54, no. 2, pp. 157–169, 1991.
- [14] H. E. Nusse and J. A. Yorke, "Border-collision bifurcations for piecewise smooth one-dimensional maps," *International Journal of Bifurcation and Chaos in Applied Sciences and Engineering*, vol. 5, no. 1, pp. 189–207, 1995.





# Hindawi

Submit your manuscripts at  
<http://www.hindawi.com>

